



Altivar Machine ATV340

Variable speed drives for
high-performance machines

Quick access to product information

Get technical information about your product

References

Modicon TM3
I/O expansion modules for Modicon controllers
Analog I/O modules

Number and type of channels	Input range	Output range	Resolution	Input terminal (Modicon)	Reference	Weight (kg)
2 management inputs	-10...+10 VDC 0...20 mA, 4...20 mA	10 mA or 10 mA + sign	12 bits or 12 bits	Terminal 2 Terminal 3	TM3AI2H TM3AI2H	0,110 0,236
4 management inputs	-10...+10 VDC 0...20 mA, 4...20 mA	10 mA or 10 mA + sign	12 bits or 12 bits	Terminal 18 Terminal 19	TM3AI4H TM3AI4H	0,110 0,236
4 management or temperature inputs	-10...+10 VDC 0...20 mA, 4...20 mA Thermocouples (K, J, E, S, T, N, R, C, O) RTDs (Pt100, Ni100, Pt1000, Ni1000)	10 mA or 10 mA + sign	12 bits or 12 bits	Terminal 18 Terminal 19	TM3AI4T TM3AI4T	0,110 0,236
4 differential temperature inputs	-10...+10 VDC 0...20 mA, 4...20 mA Thermocouples (K, J, E, S, T, N, R, C, O) RTDs (Pt100, Ni100, Pt1000, Ni1000)	10 mA or 10 mA + sign	12 bits or 12 bits	Terminal 18 Terminal 19	TM3AI4D TM3AI4D	0,110 0,236
2 management	-10...+10 VDC	10 mA or 10 mA + sign	12 bits or 12 bits	Terminal 2 Terminal 3	TM3AI2H TM3AI2H	0,110 0,236

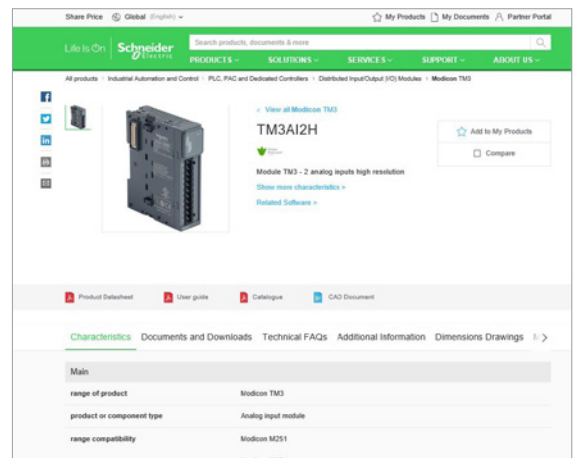

Each commercial reference presented in a catalog contains a hyperlink. Click on it to obtain the technical information of the product:

- Characteristics, Dimensions and drawings, Mounting and clearance, Connections and schemas, Performance curves
- Product image, Instruction sheet, User guide, Product certifications, End of life manual

Find your catalog



- > With just 3 clicks, you can reach the Industrial Automation and Control catalogs, in both English and French
- > Download Digi-Cat with this [link](#)

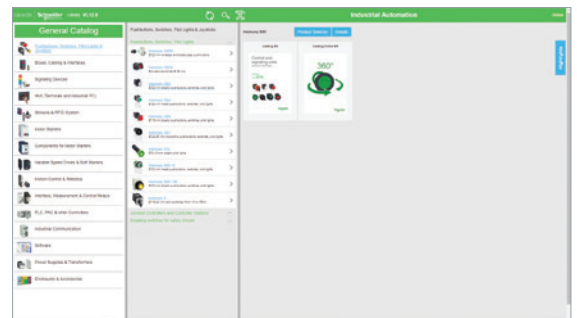

- Updated quarterly
- Embeds product selectors and configurators, 360° images, training centers,
- Optimized search by commercial reference

Select your training



- > Find the right [Training](#) for your needs on our Global website
- > Locate the training center with the selector tool, using this [link](#)

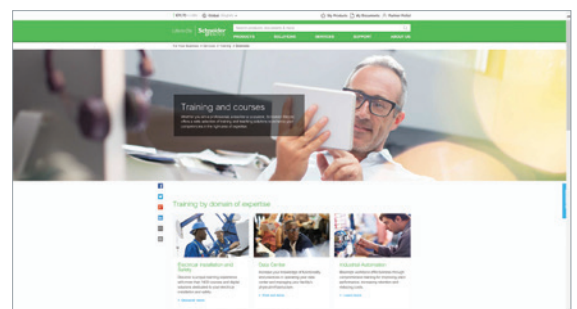

General contents

Altivar Machine ATV340 variable speed drives

<i>Introduction to EcoStruxure Machine</i>	page 2
■ Presentation	
□ General presentation	page 4
<i>Altivar Machine variable speed drives selection guide</i>	page 10
□ Altivar Machine variable speed drives presentation	page 12
■ Variable speed drives	
□ Presentation	page 16
□ Description	page 19
□ References	page 20
□ Configuration and runtime tools	page 24
■ Options	
□ Drive/option combinations	page 30
□ Encoder interface modules	page 34
□ Additional I/O modules	page 35
□ Communication buses and networks	page 36
□ Safety module	page 42
□ Additional module support	page 43
□ Braking resistors	page 44
□ EMC filters	page 46
□ Line chokes	page 48
□ dv/dt filters	page 50
□ Common mode filters	page 51
□ ATV Regenerative units	page 52
■ Motor starters	
□ Three-phase supply voltage 380...415 V 50/60 Hz	page 54
□ Three-phase supply voltage 440 V 50/60 Hz	page 55
■ Dimensions	page 56
■ Services	page 60
■ Index	page 62

To be competitive in today's digital era, machine builders must be innovative. Smart machines, those that are better connected, more flexible, more efficient, and safe, are enabling machine builders to innovate in ways never before possible.

EcoStruxure, Schneider Electric's open, IoT-enabled architecture and platform, offers powerful solutions for the digital era. As part of this, EcoStruxure Machine brings powerful opportunities for machine builders and OEMs, empowering them to offer smart machines and compete in the new, digital era.

EcoStruxure Machine brings together key technologies for product connectivity and edge control on premises, and cloud technologies to provide analytics and digital services. EcoStruxure Machine helps you bring more innovation and added value to your customers throughout the entire machine life cycle.

Innovation at Every Level for Machines is full systems across three layers:

- Connected products
Our connected products for measuring, actuating, device level monitoring, and control adhere to open standards to provide unmatched integration opportunities and flexibility
- Edge Control
We are IIoT-ready with a proven set of tested and validated reference architectures that enable the design of end-to-end open, connected, and interoperable systems based on industry standards. Ethernet and OPC UA facilitates IT/OT convergence meaning machine builders reap benefits from web interfaces and cloud.

- Apps, Analytics & Services
Seamless integration of machines to the IT layer allows the collection and aggregation of data ready for analysis – for machine builders and end users alike this means increased uptime and the ability to find information faster for more efficient operations and maintenance.

These levels are completely integrated from shop floor to top floor. And we have cloud offers and end-to-end cybersecurity wrapped around.

EcoStruxure Machine makes it easier for OEMs/ machine builders to offer their customers smarter machines. The advent of smart machines is driven by the changing needs of end users:

- Evolving workforce
- Reducing costs
- Dynamic markets
- Shorter life cycles
- Prioritizing safety and cybersecurity

EcoStruxure Machine provides one solution for the whole machine life cycle:

- With Smart Design & Engineering the time to market is reduced by up to 30% using our automated engineering and the simulation capabilities
- During Commissioning & Operation of the machine, resources such as energy, material and loss can be improved, and with seamless integration to the IT world efficiency can be improved by up to 40%
- Smart Maintenance & Services reduces the time for corrective actions up to 50%

EcoStruxure™ Machine

Innovation At Every Level



* The Schneider Electric industrial software business and AVEVA have merged to trade as AVEVA Group plc, a UK listed company. The Schneider Electric and Life is On trademarks are owned by Schneider Electric and are being licensed to AVEVA by Schneider Electric.

Variable speed drives Altivar Machine ATV340 Advanced machine performance

Altivar Machine Next level of automation performance

Altivar Machine drives offer extensive flexibility in machine applications. Depending on customer requirements, Ethernet embedded drives are available up to 75 kW and Modular and Sercos drives are available up to 22 kW.

Modular drives from 0.75 kW to 22 kW/
1HP to 30 HP
Ethernet drives from 0.75 kW to 75 kW/
1HP to 100 HP
Sercos drives from 0.75 kW to 22 kW/
1HP to 30 HP



Latest innovations
with up-to-date
technology

Altivar Machine ATV340 drives

220%

Nominal torque
for 2 s

1 ms

Application
cycle time

Advanced machine performance

Powerful dynamism and scalability

Altivar Machine ATV340 is a powerful drive that aims to match your machine's motor capabilities with maximum torque and speed performance.

With an optimized speed bandwidth up to 400 Hz, the Altivar Machine ATV340 is designed for dynamic applications that may require faster acceleration or settling time.

- > Robust enough to withstand high overloads, adaptable to the needs of demanding applications, it can provide up to 220% nominal torque for 2 s.
- > Compatible with a wide range of motors, including asynchronous (IE2, IE3) motors, synchronous motors, and reluctance motors for various applications in closed (1) and open loop, to provide the adaptability and scalability your machine requires.
- > Combination of ATV340 minimum application reaction time (1 ms task cycle) and Ethernet or Sercos connectivity, maximizing your machine throughput.

(1) Not supported by Sercos drives.

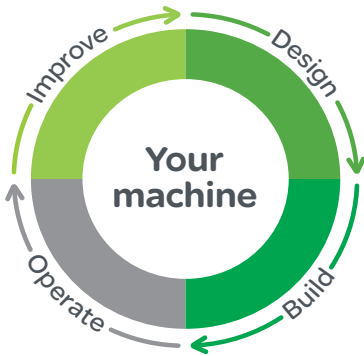

Reduced machine design time helps increase operation efficiency

Reduced machine design time

Altivar Machine ATV340 drives will help reduce your engineering time at every stage of the process to speed up machine activation and operation.

Simplified machine engineering

Altivar Machine ATV340 accommodates numerous functions and features to simplify machine design and reduces the engineering time from selection to commissioning.

- > A wealth of interfaces, numerous I/O, multi-Ethernet protocol, Sercos protocol, PTI/PTO, embedded encoders and multiple option interfaces offer maximum flexibility in architecture design.
- > Simple master/slave configuration, integrated application functions facilitate and fulfill application performance for hoisting, material handling, material working, and packaging machine segments.



TVDA's are combinations of Schneider Electric best-in-class products providing typical control architectures



FDT Technology: A widely-accepted international standard

Seamless automation integration

Ready-to-use MachineStruxure application libraries that are Tested, Validated, and Documented (TVDA), combined with Ethernet services available in ATV340, will facilitate your machine design and help you significantly reduce design time.

- > FDT/DTM technology helps ensure the interoperability and user-friendliness of ATV340 in architectures with third-party PLCs. For Sercos drives, FDT/DTM is used over Modbus serial line.
- > One button auto-tuning for motor identification simplifies commissioning and makes it possible to replicate the complete project in a fast and seamless manner for maximum productivity in machine production.



Reduced machine design time (continued)

Modicon M262 Logic controller in a Tested Validated & Documented Architecture (TVDA)

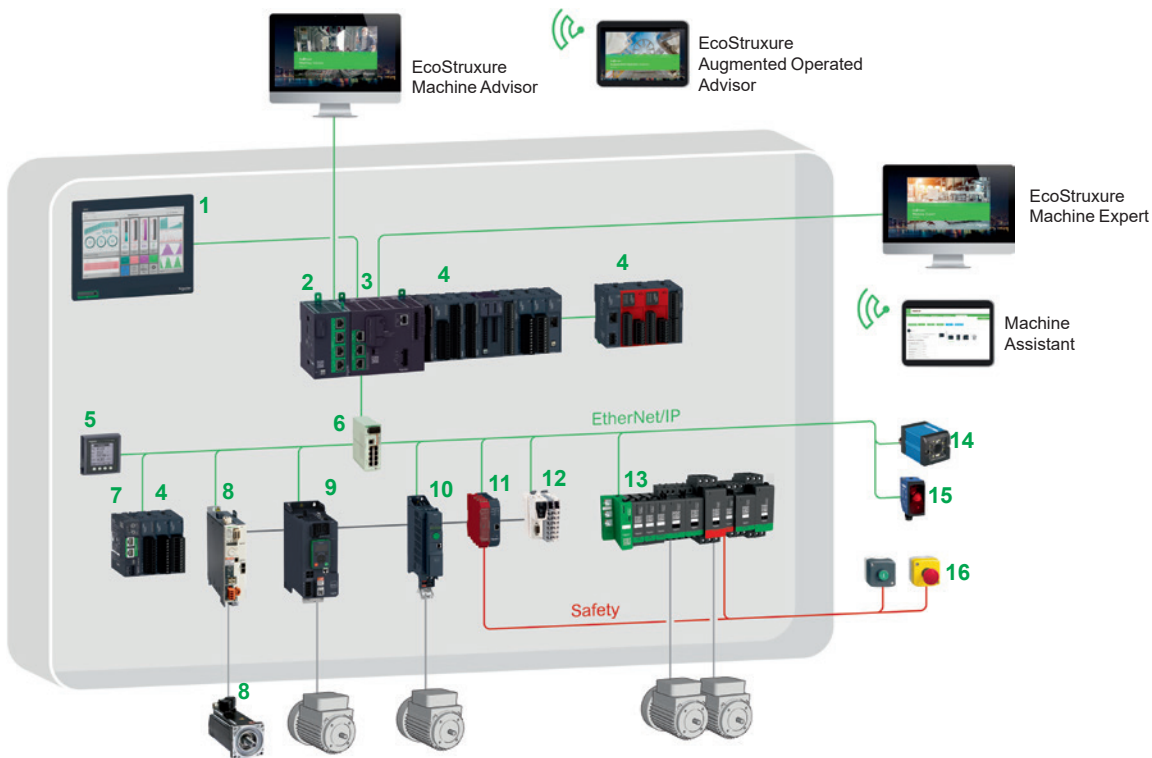

Solution breakdown (1)

- | | |
|--|--|
| <ul style="list-style-type: none"> 1 Magelis iPC: Touchscreen display 2 Modicon TMSE4 Ethernet smart communication module 3 Modicon M262 Logic controller 4 Modicon TM3 expansion modules (digital, analog, Expert, and Safety I/O) 5 Power meter 6 ConneXium Ethernet switch 7 Modicon TM3 Ethernet bus coupler 8 Lexium 32M servo drives and BMH/BSH servo motor | <ul style="list-style-type: none"> 9 Altivar Machine ATV340S variable speed drive 10 Altivar Machine ATV320 variable speed drive 11 Preventa XPSMCM modular Safety controller 12 Modicon TM5 Ethernet interface module 13 TeSys island load management system 14 Barcode reader 15 Telemecanique Sensors proximity sensors 16 Harmony® XB5 plastic pushbutton and Emergency stop |
|--|--|



(1) Please refer to our catalogs on [Digi-Cat](#) (download Digi-Cat)

Reduced machine design time (continued)

Modicon M262 Motion controller in a Tested Validated & Documented Architecture (TVDA)

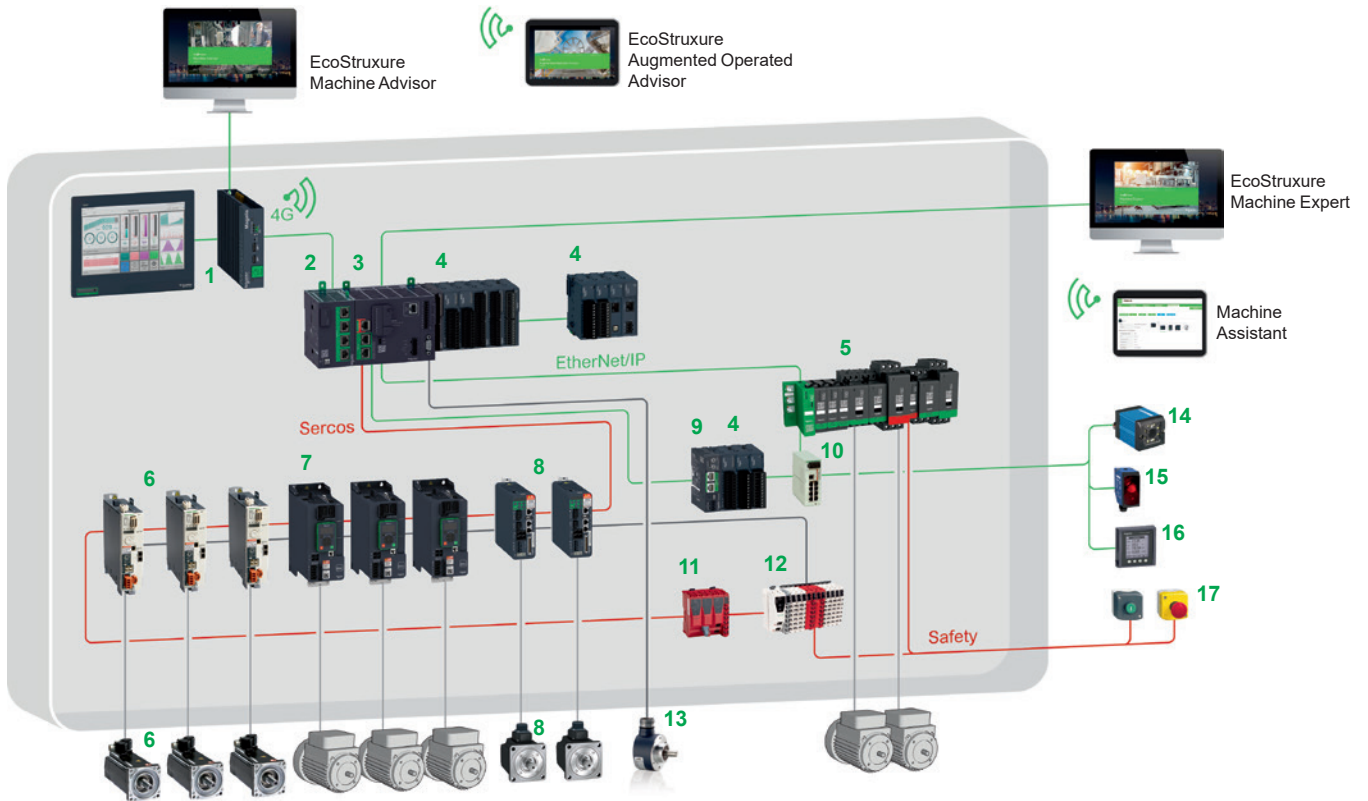

Solution breakdown (1)

- | | |
|--|--|
| <ul style="list-style-type: none"> 1 Magelis iPC: Touchscreen display and IIoT Edge Box 2 Modicon TMSES4 smart communication module 3 Modicon M262 Motion controller 4 Modicon TM3 expansion modules (digital, analog, and Expert I/O) 5 TeSys island load management system 6 Lexium 32S servo drives and BMH/BSH servo motors 7 Altivar Machine ATV340S variable speed drives 8 Lexium 28 servo drives and BCH2 servo motors 9 Modicon TM3 Ethernet bus coupler | <ul style="list-style-type: none"> 10 ConneXium Ethernet switch 11 Modicon TM5CSLC Safety logic controller 12 Modicon TM5: Sercos interface module and I/O modules (digital, analog, and Safety I/O) 13 Encoders 14 Barcode reader 15 Telemecanique Sensors proximity sensors 16 Power meter 17 Harmony® XB5 plastic pushbutton and Emergency stop |
|--|--|



(1) Please refer to our catalogs on [Digi-Cat](#) (download Digi-Cat)

+ Ideal for the design service concept

Reduced machine design time (continued)

Industrial Ethernet architecture

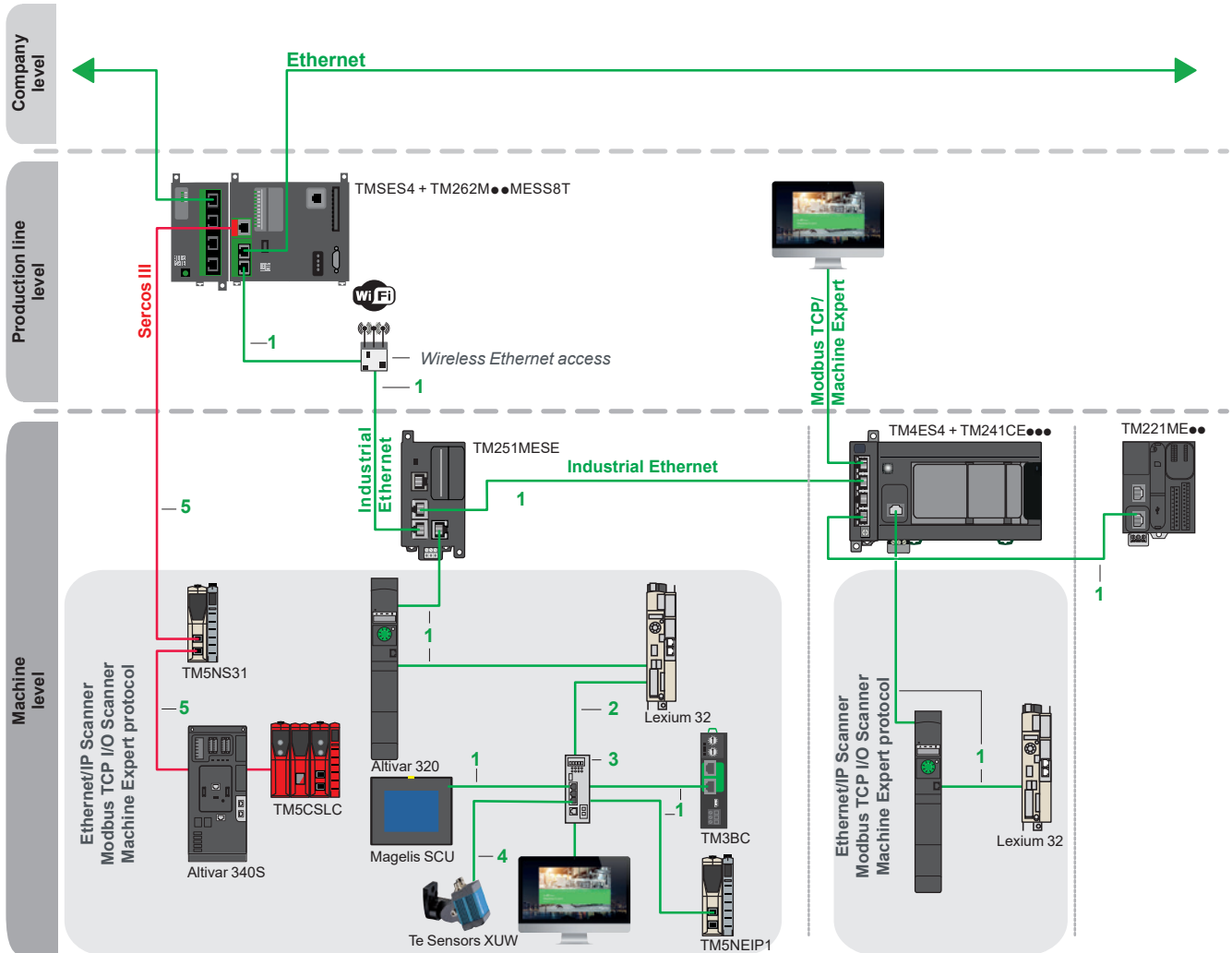

Items 1, 2, 3, and 5: Please refer to Industrial Ethernet catalog ref. [DIA3ED2160105EN](#).

Item 4: Ethernet **XGSZ●2E45●●** extension cables (M12 straight/RJ45, shielded cable, straight cabling) for **XUW** vision sensors (1).

Shielded copper connection cables

ConneXium shielded connection cables are available in two versions to meet the various current standards and approvals:

■ EIA/TIA 568 shielded twisted pair cables for CE market

These cables conform to:

- EIA/TIA-568 standard, category CAT 5E
- IEC 11801/EN 50173-1 standard, class D

Their fire resistance conforms to:

- NF C32-070 standard, class C2
- IEC 322/1 standards
- Low Smoke Zero Halogen (LSZH)

■ EIA/TIA 568 shielded twisted pair cables for UL market

These cables are:

- CEC type FT-1
- NEC type CM

A new range of **ConneXium** fully shielded preformed cordsets has been specially designed for use in harsh industrial environments.

These cordsets combine a category 5E shielded cable and RJ45 connectors reinforced with a metal profile. Please refer to catalog ref.

[DIA6ED2140903EN](#).

(1) More information is available on our partner website [Telemecanique sensors](#).

+ Accelerate operation efficiency with machine drives



Achilles™ Level 2 certified



Cybersecurity for your assets

Sustained machine operation

Robust design for long-lasting operation and reliable service

ATV340 has been designed to meet the needs of applications for harsh environments such as vibration, shock and non-conductive dust, and where high temperature resistance up to 60 °C/140 °F is needed.

Help to protect people and assets while providing continuity of service

Compliant with machine safety and cybersecurity standards, Altivar Machine ATV340 drives offer an embedded solution that can form part of your enduring protection system for your people and assets.

- > Compliant with machine-related safety standards EN ISO 13849-1 and EN 62061
- > Achilles Level 2 certification against cyber attacks

Fast machine recovery

The Altivar Machine 340 keeps your machine up and running with minimal downtime due to features that include:

- > Fast Device Replacement (FDR) service: With the MachineStruxure architecture in place, device replacement takes just two simple steps by the service technician. Firstly, the pluggable connectors mean a new drive can be fitted in less than 3 minutes, then the drive configuration can be downloaded from the PLC in a single action.
- > Data logging and monitoring by the local system or remote monitoring via the embedded Web server give users access to any motor or application-relevant data anytime, anywhere. This information can be used for predictive maintenance and to avoid breakdowns.

Communication protocol efficiency

Smart design makes the Modicon M262 the IIoT- ready controller for Logic and Motion machines.

- > It offers a real-time automation fieldbus with Sercos for fast motion control, Safety functions, and openness to other devices.
- > One cable simplifies the architecture and fieldbus wiring, allowing EtherNet/IP and Sercos devices to be managed on the same cable.

Modicon M262 Motion controller, optimized local I/O with Modicon TM3

Modicon TM5 Safety logic controller, Modicon TM5 Sercos interface module, Modicon TM5 Safety I/O, Modicon TM7 Safety I/O

Optimized I/O with Modicon TM3: Distributed I/O on Ethernet with TM3 bus coupler

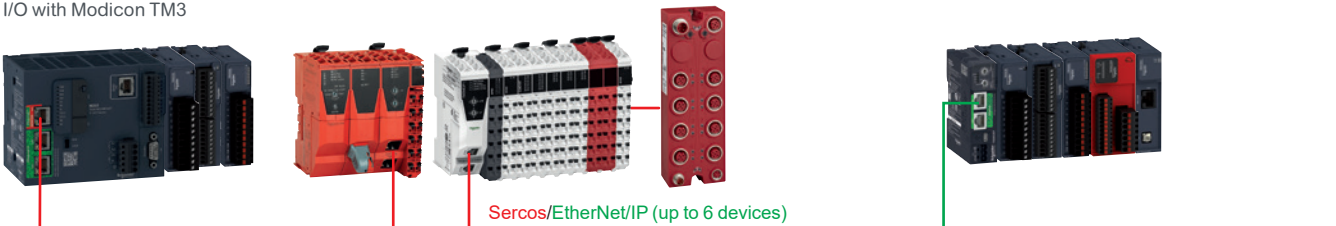

Lexium LXM32S



Altivar Machine ATV340S



TeSys Island: connected load management system



Performance I/O with Modicon TM5: Distributed I/O on Ethernet with TM5 interface module

+ Ideal for the design service concept

Altivar Machine variable speed drives

Application segments	General Specific
----------------------	---------------------

Material handling, packaging, textiles, hoisting, mechanical actuators, material working
Conveyors, carton packers, gantry cranes, woodworking, metal processing, fans, etc.



Degree of protection	IP20	IP20
Power range for 50..60 Hz supply	Single-phase 200...240 V 0.18...2.2 kW/0.25... 3 HP Three-phase 200...240 V 0.18...15 kW/0.25...20 HP Three-phase 380...480 V – Three-phase 380...500 V 0.37...15 kW/0.5...20 HP Three-phase 525...600 V 0.75...15 kW/1...20 HP	0.18...2.2 kW/0.25... 3 HP – 0.37...15 kW/0.5...20 HP – 0.75...15 kW/1...20 HP
Drive	Output frequency 0.1...599 Hz Control type Asynchronous motor Synchronous motor Motor sensor Integrated Available as an option Overload torque performance	– U/F ratio (2 points, 5 points, energy saving, quadratic), flux vector control without sensor (standard and energy saving) Vector control without sensor – RS422 (speed monitoring) Up to 200% Tn of overtorque, and 170% Tn of braking torque for open loop motor control
Functions	Advanced functions – Integrated Safety functions Number of preset speeds	<ul style="list-style-type: none"> Control of asynchronous and synchronous motors; including IE2, IE3, and PM motors in open loop MachineStruxure integration in EcoStruxure Machine Expert Operation in Velocity mode and Torque control (with current limitation) Customizable and flexible application functions with ATV Logic (up to 50 function blocks) Numerous application functions for targeted application segments Embedded Safety functions dedicated to targeted application segments STO (up to SIL3/PLe), SS1, SLS, SMS, GDL 16
Number of integrated I/O	Analog inputs Digital inputs Analog outputs Digital outputs Relay outputs Safety function inputs	3: 1 bipolar differential input ±10 V, 1 voltage input (0...10 V), and 1 current input (0-20 mA) 6: 4 configurable inputs (positive or negative logic), 1 input with PTC probe, 1 x 20 kHz pulse input 1: Configurable as voltage (0...10 V) or current (0-20 mA) 1: Configurable as sink or source 2: 1 with NO/NC contacts and 1 with NO contacts 1 + 4: 1 with STO and 4 configurable for Safety functions from digital inputs
Optional additional I/O module	–	–
Communication	Integrated Optional	Single port compatible with CANopen and Modbus Serial line Ethernet IP and Modbus TCP, CANopen RJ45 Daisy Chain, Sub-D, and screw terminals, PROFINET, Profibus DP V1, EtherCAT, DeviceNet, and POWERLINK
Configuration and runtime tools	–	Integrated display, DTM (Device Type Manager), SoMove software, Simple Loader (optional), Multiloader (optional), and remote graphic terminal (optional)
Standards and certifications	–	IEC 61800-5-1, IEC 61800-3 (environments 1 and 2, category C2), UL 508C, EN 954-1 category 3, ISO/EN 13849-1/- 2 category 3 (PL e), IEC 61508 (parts 1 & 2) SIL 2 level, draft standard EN 50495E IEC 60721-3-3, classes 3C3 and 3S2 CE, UL, CSA, RCM, EAC, ATEX
References	ATV320●●●●●C	ATV320●●●●●B

Packaging, material handling, material working, hoisting
Palletizers, shrink wrapping machines, cardboard box folding machines, standard cranes, automatic storage systems, grouping conveyors, slitters, etc.



IP20	IP20	IP20	IP20
–	–	–	–
0.75...22 kW/1...30 HP	0.75...22 kW/1...30 HP	30...75 kW/40...100 HP	0.75...22 kW/1...30 HP
–	–	–	–
0.1...599 Hz	Voltage vector control without sensor, current vector control with sensor, U/F 5 points, energy saving mode		
–	Open-loop synchronous motor control (with and without stall monitoring), closed-loop synchronous motor control, synchronous reluctance motor control		Open-loop synchronous motor control (with and without stall monitoring), synchronous reluctance motor control
–	RS422 incremental, Sincos Digital (RS422 incremental, EnDat2.2, SSI), analog (sin/cos 1Vpp), resolver Up to 220% Tn in open loop or closed loop control		
–	Up to 180% Tn in open or closed loop control	Up to 180% Tn in open or closed loop control	Up to 220% Tn in open loop or closed loop control
–	<ul style="list-style-type: none"> Control of asynchronous, synchronous, special motors including all efficiency classes, PM motors, torque motors, conical sliding rotor, reluctance Advanced MachineStruxure integration in EcoStruxure Machine Expert Operation in Velocity mode, Torque mode Possibility of adding additional I/O or optional encoder feedback modules Numerous application functions for targeted application segments Very dynamic motor control performance (up to 400 Hz speed bandwidth) and cyclic application task (1 ms) Possibility of Master/Slave daisy chain through PTO/PTI Integrated Ethernet IP and Modbus TCP dual port, cybersecurity (Achilles Level 2) Via integrated Web server continuous and real-time application data with customizable dashboards Master/Slave drive-to-drive link via Ethernet		
–	STO SIL3/PLe with dual input		–
2: 1 configurable input (voltage/current/thermal probe) and 1 bipolar differential input ±10 V ---	3: Configurable as voltage (0...±10 V ---) or current (0-20 mA/4-20 mA), including 2 for probes (PTC, PT100, PT1000, or KTY84)	2: 1 configurable input (voltage/current/thermal probe) and 1 bipolar differential input ±10 V ---	–
5 + 2: 5 configurable inputs (positive or negative logic) and 2 that can be configured as digital input or output	8: Configurable inputs (positive or negative logic)	5 + 2: 5 configurable inputs (positive or negative logic) and 2 that can be configured as digital input or output	–
1: Configurable as voltage (0...10 V ---) or current (x...20 mA)	2: Configurable as voltage (0...10 V ---) or current (x...20 mA)	1: Configurable as voltage (0...10 V ---) or current (x...20 mA)	–
2: Assignable	1: Assignable	2: Assignable	–
2: 1 with NO/NC contacts and 1 with NO contacts	3: 1 with NO/NC and 2 with NO contacts	2: 1 with NO/NC and 1 with NO contacts	–
2: STO_A\, STO_B\ for STO Safety function	2: STO_A\, STO_B\ for STO Safety function	2: STO_A\, STO_B\ for STO Safety function	–
Extended I/O module and/or extended relay module			
2 ports for Modbus serial line	Dual port for Ethernet IP/Modbus TCP, 2 ports for Modbus serial line	Dual port for Sercos, 2 ports for Modbus serial line	–
CANopen RJ45 Daisy Chain, Sub-D, and screw terminals, PROFINET, Profibus DP V1, EtherCAT, DeviceNet, and POWERLINK	–	–	–
Status display LEDs, display terminal (optional), DTM (Device Type Manager), SoMove software, EcoStruxure Machine Expert software	Status display LEDs, embedded Web server, display terminal (optional), DTM (Device Type Manager), SoMove software, EcoStruxure Machine Expert software	Status display LEDs, display terminal (optional), SoMove software used with DTM over Modbus Serial line, EcoStruxure Machine Expert software	–
UL508C/UL61800-5-1, EN/IEC 61800-3, Environment 1 category C2, EN/IEC 61800-3, Environment 2 category C3, EN/IEC 61800-5-1, IEC 60721-3-3, classes 3C3 and 3S3, IEC 61508, IEC 13849-1, Green Premium, Reach/RoHS			
CE, UL, CSA, TÜV, Green Premium, RoHS EU, China			
ATV340●●●N4	ATV340●●●N4E	ATV340●●●N4S	–

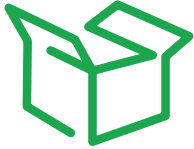

Packaging

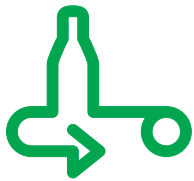

Material handling



Material working



Hoisting



Consumer packaged goods



Textiles

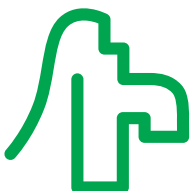

Pumping



General machine control

Machine solution

The Altivar Machine ATV340 is an IP20 high-performance variable speed drive for three-phase synchronous and asynchronous motors in open and closed loop control (1). ATV340 incorporates functions and features suitable for the most common applications, including:

- Packaging
- Material handling
- Material working
- Hoisting
- Consumer packaged goods
- Textiles
- Pumping
- General machine control

Designed to meet the needs of the most demanding automation applications, the Altivar Machine ATV340 achieves high levels of machine performance and throughput. This is combined with simplicity in selection, engineering and design (automation integration), commissioning, machine mass production, and sustained machine operation, including services for machine builders.

The ATV340S, a variable speed drive with a Sercos interface, is designed and tested for a PacDrive system architecture. Typical applications are parcel handling and motion machine architectures.

The ATV340S supports the function "Open loop speed control" as a SercDrive object without license points.

The PacDrive LMC controller generates the motion profile (cyclic position setpoints over Sercos). The Sercos communication module in the ATV340 converts the position into a speed and transmits it to the drive.

The Altivar Machine ATV340 offers realtime automation capabilities, simplified machine engineering, and superior performance for industrial machine applications:

- Dynamic and powerful motor control for asynchronous, synchronous, and reluctance motors
- Drive cycle in real time for the most demanding automation requirements
- Complete integration into any system architecture by offering a native Ethernet product in real time and commonly used industrial communication fieldbuses (CANopen, Profinet, EtherCAT, etc.). ATV340 Sercos is used in a solution approach, together with the PacDrive Controller LMC Eco or LMC Pro2.
- The drive features and dedicated application functions are the benchmark for high performance requirements
- Safe torque off (STO) with dual inputs compliant with SIL3/PLe to meet machine safety standards
- Data logging, Web server, I/O scanning, easy addressing, and many other services are possible with the Ethernet version, reducing the machine design time and improving machine operation.

The Altivar Machine ATV340 helps enhance machine performance, reduce machine design time, and maintain machine operation, meeting the needs of original equipment manufacturers by pinpointing all the vital stages of the machine lifecycle.

Schneider Electric's MachineStruxure solutions provide abundant ready-to-use, PLCopen-compliant libraries. EcoStruxure Machine Expert can be used to develop, configure, and set up an entire machine in a single software environment. Using FDT/DTM technology, it is possible to configure, control, and diagnose Altivar Machine ATV340 drives directly in EcoStruxure Machine Expert and SoMove software by means of the same software brick (DTM).

EcoStruxure Machine Expert provides verified and documented application libraries for Altivar Machine ATV340 with seamless integration under this platform. Altivar Machine ATV340 has the advantage of reducing engineering and design time for machine builders.

(1) Not supported by Sercos drives.



Packing and packaging machines

Applications

Altivar Machine ATV340 drives embed functions for high-performance machine requirements in the following applications:

Packaging

- Control via built-in Ethernet network (Modbus TCP/IP, SERCOS III) or optional communication networks (Ethernet IP and Modbus TCP, CANopen, PROFINET, Profibus DP V1, EtherCAT, and DeviceNet)
- Very quick response times on transmission of a command: 1 ms (± 0.5 ms)
- Up to 400 Hz speed bandwidth
- Side-by-side mounting to save space inside enclosure
- Advanced synchronous and synchronous reluctance motor open loop control achieves energy saving performance
- Advanced induction and synchronous closed loop control for high-performance motor control



Consumer packaged goods machinery

Consumer packaged goods machinery

- Control via built-in Ethernet network (Modbus TCP/IP, SERCOS III) or optional communication networks (Ethernet IP and Modbus TCP, CANopen, PROFINET, Profibus DP V1, EtherCAT, and DeviceNet)
- Very quick response times on transmission of a command: 1 ms (± 0.5 ms)
- Up to 400 Hz speed bandwidth
- Side-by-side mounting to save space inside enclosure
- Advanced synchronous and synchronous reluctance motor open loop control achieves energy saving performance
- Advanced induction and synchronous closed loop control for high-performance motor control
- Normal duty sizing
- PID regulator with preset reference
- Warning monitoring functions
- Process load monitoring function
- Separate 24 V for control PCBA board (application function and Safety function). In case of power outage on site, the PLC can still retrieve information with the redundant power supply via communication protocols.



Material working

Material working

- Double STO inputs SIL3
- Optional Safety module for operation compliant with applicable safety standards
- Control via built-in Ethernet network (Modbus TCP/IP, SERCOS III) or optional communication networks (Ethernet IP and Modbus TCP, CANopen, PROFINET, Profibus DP V1, EtherCAT, and DeviceNet)
- Advanced induction and synchronous closed loop control for high-performance motor control
- Embedded encoder input that the user can use as a speed and torque reference
- Fastest possible controlled stop on loss of line supply
- Motor thermal monitoring and protection function
- Torque limitation
- DC sharing and optional compact design regenerative braking unit (ATV regen)
- PTO/PTI functions, achieve 1 to N gearing function depending on setting
- 220% over torque capability, allows a more dynamic response

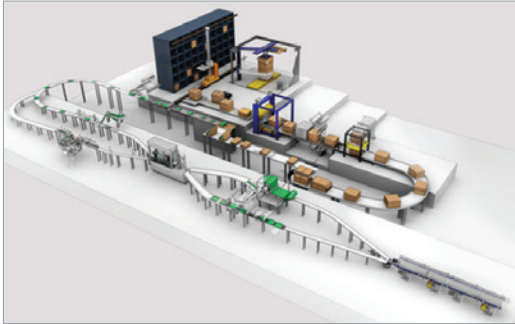

Material handling

Applications (continued)

Material handling

- Very quick response times on transmission of a command: 1 ms (± 0.5 ms)
- Reference via pulse input or analog input as Speed/Torque reference, to adapt hardwired onsite solution
- Control via built-in Ethernet network (Modbus TCP/IP, SERCOS III) or optional communication networks (Ethernet IP and Modbus TCP, CANopen, PROFINET, Profibus DP V1, EtherCAT, and DeviceNet)
- Position control via limit switches with time optimization at low speed
- Multiple parameter settings via parameter set switching
- Speed and torque master/slave function
- Load sharing
- Advanced induction and synchronous closed loop control for high-performance motor control
- Advanced synchronous and synchronous reluctance motor open loop control achieves energy saving performance
- Separate 24 V for control PCBA board (application function and Safety function). In case of power outage on site, the PLC can still retrieve information with a redundant power supply via communication protocols.



Hoisting

Hoisting

- Control via built-in Ethernet network (Modbus TCP/IP, SERCOS III) or optional communication networks (Ethernet IP and Modbus TCP, CANopen, PROFINET, Profibus DP V1, EtherCAT, and DeviceNet)
- Brake control adapted for horizontal and vertical movement
- Brake feedback management (for Safety level PLc Cat. 2 compliance)
- Dedicated speed monitoring function with embedded encoder input
- Load measurement using weight sensor
- High-speed hoisting with rope slack
- Load sharing
- Limit switch management
- Multiple motors/configurations
- High speed unit switching function
- DC sharing and optional compact design regenerative braking unit
- Optional Safety module for operation compliant with applicable safety standards (for Safety level PLd Cat. 3)



Textile application

Textiles

- Control via built-in Ethernet network (Modbus TCP/IP, SERCOS III) or optional communication networks (Ethernet IP and Modbus TCP, CANopen, PROFINET, Profibus DP V1, EtherCAT, and DeviceNet)
- Double STO inputs, up to SIL3 level
- High resolution of the digital speed reference
- Advanced synchronous and synchronous reluctance open loop control achieves energy saving performance
- Up to 400 Hz speed bandwidth with high-performance speed loop
- DC sharing and optional compact design regenerative braking unit
- Fastest possible controlled stop on loss of line supply
- Side-by-side mounting to save space inside enclosure
- High temperature operating range, up to 60 °C/140 °F
- 3C3 and 3S3 PCBA coating



Pumping

Applications (continued)

Pumping

- Normal duty sizing
- Dedicated motor control law for centrifugal pumps with optimized energy saving
- Advanced synchronous and synchronous reluctance open loop control achieves energy saving performance
- PID regulator with preset reference
- 16 preset speeds
- Multi motor management
- Warning monitoring functions
- Process load monitoring function
- Error detection disable function used in specific situations such as smoke extraction
- STO function for limit pressure emergency
- Communication networks for industry and infrastructure applications
- Separate 24 V for control PCBA board (application function and Safety function). In case of power outage on site, the PLC can still retrieve information with a redundant power supply via communication protocols.



General machine control

General machine control

- Control via built-in Ethernet network (Modbus TCP/IP, SERCOS III) or optional communication networks (Ethernet IP and Modbus TCP, CANopen, PROFINET, Profibus DP V1, EtherCAT, and DeviceNet)
- Separate 24 V for control PCBA board (application function and Safety function). In case of power outage on site, the PLC can still retrieve information with a redundant power supply via communication protocols.
- PID regulator
- 16 preset speed functions
- +/- speed
- Reference operation
- Line contactor and output contactor control
- Speed or torque control with current/torque limitation
- Speed and torque master/slave function, load sharing
- DC sharing and optional compact design regenerative braking unit
- Embedded encoder input that the user can use as a speed and torque reference
- Advanced motor control laws: V/F 5 points, sensorless vector control, synchronous permanent magnet motor control, synchronous reluctance motor control, and energy saving, allow users to configure different machine behaviors
- Embedded Web server for advanced maintenance (IoT-ready)



ATV340U22N4 (1) ATV340U75N4 (1)



ATV340U22N4E (1) ATV340U75N4E (1) ATV340D22N4E (1)



ATV340U22N4S ATV340U75N4S ATV340D22N4S



ATV340D37N4E (1) ATV340D75N4E (1)

The offer

The Altivar Machine ATV340 range of variable speed drives covers motor power ratings from 0.75 kW/1 HP to 75 kW/100 HP in heavy duty, with 3 product types: Modular, Ethernet and Sercos products:

- 380 V...480 V three-phase, 0.75 kW/1 HP to 22 kW/30 HP covers Modular type (ATV340U07N4 to ATV340D22N4)
- 380 V...480 V three-phase, 0.75 kW/1 HP to 75 kW/100 HP covers Ethernet type (ATV340U07N4E to ATV340D75N4E)
- 380 V...480 V three-phase, 0.75 kW/1 HP to 22 kW/30 HP covers Sercos type (ATV340U07N4S to ATV340D22N4S)

The Modular type is designed to accommodate the majority of commonly-used industrial fieldbus protocols for simple integration in various automation architectures. References ending with "E" indicate the Ethernet version product with multi-protocol Ethernet embedded. The multi-Ethernet protocol consists of Ethernet IP and Modbus TCP communication interfaces.

All three versions have a book format up to 7.5 kW/10 HP and all sizes can be mounted side by side in order to optimize the machine footprint.

The Altivar Machine ATV340 range is designed to withstand harsh ambient conditions, as references comply with IEC 60721-3-3 Class 3C3 and 3S3 and can operate up to 60 °C/140 °F with derating and 50 °C/122 °F without derating as standard.

The Altivar Machine ATV340 drives integrate Modbus serial line communication protocols as standard. Each device is equipped with 2 RJ45 ports dedicated to:

- Drive connection for configuration software
- Connecting an HMI (keypad) to the drive

In addition, the ATV340 Ethernet drives contain dual RJ45 port multi-Ethernet protocol. The multi-Ethernet protocol integrates Ethernet IP and Modbus TCP as standard.

The Ethernet drives are able to accommodate 2 slots for option modules serving different purposes.

- GP – SF slot dedicated to optional Safety function module and additional I/O module
- GP – ENC slot designed to take an encoder option module or additional I/O module

Modular drives ATV340U●●N4 are equipped with 3 slots for optional modules, the GP – FB slot being the only difference from the ATV340 Ethernet drive.

The GP – FB slot can be used for a communication option module to control the drive. ATV340 Modular drives are compatible with the communication interfaces below:

- CANopen
- PROFIBUS DP V1
- DeviceNet
- EtherCAT
- Profinet
- POWERLINK

See [page 36](#).

Heavy duty sizing as standard

Altivar Machine ATV340 drives are sized heavy duty as standard. In the case of lower cycle applications (requiring lower starting current) ATV340 drives can also be sized as normal duty:

■ Heavy duty: Dedicated mode for applications requiring significant overload (up to 1.5 In for 60 s and up to 1.8 In (2) for 2 s), the recommended drive selection is standard sizing.

■ Normal duty: Dedicated mode for applications requiring slight overload (up to 1.2 In for 60 s and up to 1.35 In for 2 s), the recommended drive selection is one rating lower. For more details please refer to the [installation manual](#).

Torque/Speed accuracy

- Speed accuracy
 - +/- 10% of nominal slip 0.2 Tn to Tn torque variation without speed feedback
 - +/- 0.01% of nominal speed 0.2 Tn to Tn torque variation in closed-loop mode with encoder feedback
- Torque accuracy
 - +/- 10% in open-loop mode, without speed feedback
 - +/- 5% in closed-loop mode with encoder feedback
- Transient overtorque capability
 - 220% of nominal motor torque +/- 10% for 2 s
 - 180% of nominal motor torque +/- 10% for 60 s

(1) Drives are shown with optional plain text display, which can be ordered as an add-on.

(2) See the selection table on [page 20](#).

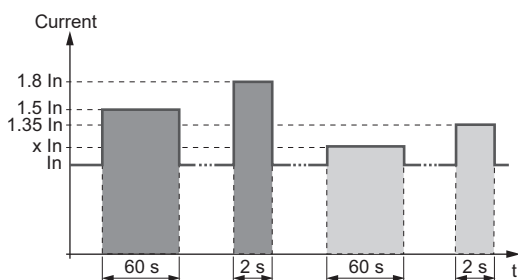

- Heavy duty operating mode
- Normal duty operating mode

Note:

For ATV340U07...D22N4● drives, x In = 1.1 In

For ATV340D30...D75N4E drives, x In = 1.2 In

For ATV340U22...U75N4S drives, x In = 1.1 In

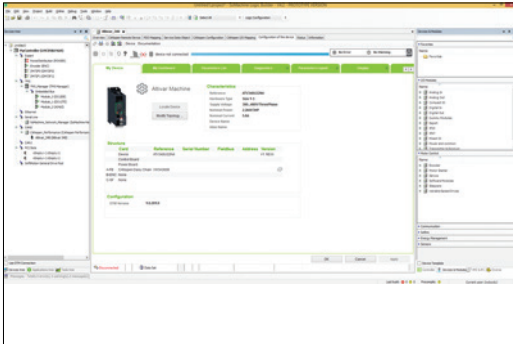

Altivar Machine DTM in EcoStruxure Machine Expert

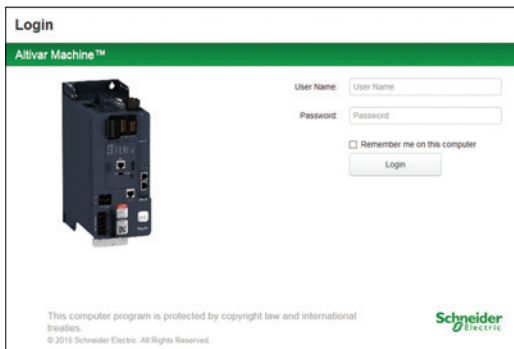

Embedded Web server login screen

Integration

Fieldbus protocols

- EtherNet/IP and Modbus/TCP dual port (1) and Modbus serial link:
 - Standard Modbus and Ethernet protocols
- Sercos dual port and Modbus serial link
- Connection of configuration and runtime tools
- Control of the Altivar Machine ATV340 in automation architectures (PLCs, IPCs, HMIs, etc.) in industrial network protocols for reading/writing data (2):
 - Diagnostic, supervision, and fieldbus management functions
- Ethernet services:
 - SNMP, SNTP, BootP & DHCP, IP v6, cybersecurity services, FDR
 - Open Ethernet topologies

Integration of configuration and runtime tools

- FDT/DTM technology (see [page 29](#)):
 - Drive configuration, diagnostics, and control using EcoStruxure Machine Expert software with Modicon Machine Solution controllers
 - Drive configuration, diagnostics, and control using EcoStruxure Machine Expert software with PacDrive Machine Solution controllers, for Sercos drive

Dialog and configuration tools

- LED display terminals on front:
 - Monitoring drive status
- Graphic display terminal (see [page 24](#)) (3):
 - Drive control, adjustment, and configuration
 - Display of current values (motor, I/O, etc.)
 - Configuration storage and download
 - Duplication of one drive configuration on another drive from a PC or another drive
 - Connection to several drives using multidrop link components (see [page 37](#))
- Embedded Web server (see [page 28](#)) (4):
 - Easily accessible from any PC, iPhone, iPad, Android system, and major Web browsers
 - Network diagnostics in real time
 - Read/write values
- SoMove software (see [page 29](#)):
 - Advanced functions for configuration, setup, and maintenance of Altivar Machine drives

Accessories and replacement parts

Accessories

- Display terminal:
 - Plain text display for direct or remote mounting (see [page 24](#))
 - Graphic display terminal for extended mounting (see [page 26](#))
 - Remote mounting kit for mounting on enclosure door (see [page 25](#))
 - Multidrop connection accessories for connecting several drives to the RJ45 terminal port (see [page 37](#))
- Drive-to-drive plus connection accessories (see [page 23](#)) (4)
- Flange mounting kit: design for evacuating dissipated heat through the power section by mounting the power part outside an electrical cabinet (see [page 23](#))
- Daisy chain DC bus sharing cable for cost-optimized installations, to create a simple DC bus link (see [page 23](#))

Replacement parts

- Fan kit (see [page 23](#))
- Connector kits for I/O, motor, and power connection (see [page 23](#))

(1) Ethernet devices only.

(2) See previous page for compatible automation fieldbuses in addition to Ethernet IP and Modbus TCP.

(3) There are 2 possible options for display: mounting on the drive or mounting on the enclosure door using the mounting kit and extension accessories.

(4) Not supported by Sercos drive.



Inserting relay module VW3A3204 into slot GP-SF of the Ethernet ATV340 drive, ATV340U07N4E

Options

- Modules (see [page 34](#)):
- Encoder modules (see [page 34](#)):
 - Digital interface encoder module 5/12 V
 - Resolver interface module
 - Analog interface encoder module
- Additional I/O (see [page 35](#)):
 - 2 analog inputs
 - 6 digital inputs
 - 2 digital outputs
 - 3 NO contacts with relay output
- Communication (see [page 36](#)) (1):
 - CANopen: RJ45 daisy chain, SUB-D, 5-way screw terminals
 - PROFINET
 - Profibus DP V1
 - EtherCAT
 - DeviceNet
 - POWERLINK
- Braking resistors (see [page 44](#))
- Additional EMC input filters for reducing conducted emissions on the AC supply (see [page 46](#))
- Line chokes to reduce the THDi of a system (see [page 48](#))

Motor starters

Schneider Electric offers combinations of circuit breakers and contactors so that Altivar Machine drives can be used in optimum conditions (see [page 54](#)). For prospective line short-circuit currents up to 100 kA, please contact our [Customer Care Center](#).

Standards and certifications

Altivar Machine ATV340 drives have been developed to conform to the international standards and recommendations relating to industrial electrical control devices (IEC), in particular:

- UL508C/UL61800-5-1
- IEC 61800-3:
 - EN/IEC 61800-3, Environments 1 category C2
 - EN/IEC 61800-3, Environments 2 category C3
- EN/IEC 61800-5-1
- IEC 60721-3
- IEC 61508
- IEC 13849-1
- Green Premium, Reach/RoHS

Altivar Machine ATV340 drives are certified:

- UL
- CSA
- TÜV
- Green Premium, RoHS EU, China

They are CE marked according to the European low voltage (2014/35/EU) and EMC (2014/30/EU) directives.

(1) Not supported by Sercos drives.

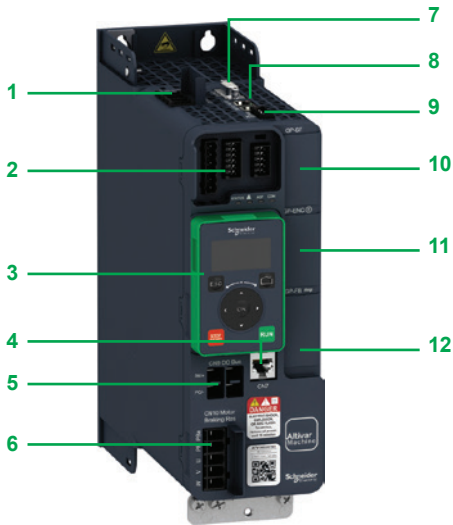

ATV340 Ethernet drive equipped with plain text display terminal

Description

- 1 Power supply terminals
- 2 I/O connection (1):
 - 5 digital inputs:
 - Configurable as positive digital input (source) or negative digital input (sink) compliant with IEC61131-2 PLC standards:
 - 24 V $\overline{\text{---}}$, impedance 4.4 k Ω , sampling time 1 ms +/- 250 μs , response time 1 ms
 - 2 digital inputs or outputs:
 - Configurable and compliant with IEC61131-2 PLC standards
 - 24 V $\overline{\text{---}}$, sampling time 2 ms, maximum voltage 30 V, maximum current 100 mA
 - 2 relay outputs: R1 (3 NO and NC contacts) and R2 (2 NC contacts)
 - R1 - 1 NC contact and 1 NO contact with common point, minimum switching capacity 5 mA for 24 V $\overline{\text{---}}$, maximum switching capacity 3 A on resistive load, 2 A on inductive load for 250 V \sim or 30 V $\overline{\text{---}}$
 - R2 - 1 NC contact, maximum switching capacity 5 A on resistive load
 - 2 analog inputs:
 - 1 configurable (voltage/current/PTC-PT100) analog input, by programming X and Y from 0 to 20 mA
 - 1 bipolar ± 10 V $\overline{\text{---}}$ analog input, sampling time 250 μs
 - 1 analog output, 2 ms +/- 0.5 ms sampling time and 10-bit resolution, configurable as:
 - Voltage analog output 0...10 V $\overline{\text{---}}$, minimum load impedance 470 Ω
 - Current analog output "x to y" mA, maximum load impedance 500 Ω
- 3 Plain text display terminal (can be mounted as an option)
- 4 Modbus Serial line RJ45 port
- 5 DC Bus connection link (2)
- 6 Motor and braking resistor connector
- 7 Encoder feedback interface is compatible with RS422 incremental (A/B/I) and Sin/Cos 1 Vpp (SC) interfaces, 5 V, 12 V, and 24 V supply voltage (3)
- 8 Pulse train output (PTO) and pulse train input (PTI) interface can be used to control the drive via PLC or using hardwired master/slave applications. The interface is equipped with 2 RJ45 ports and the pulse counter can be set at 0...200 kpps (4) (7)
- 9 Safe torque off (STO) dual input SIL3/PLe and 24 V $\overline{\text{---}}$ supply in/out
- 10 GP – SF slot for Safety option module (7) or additional I/O module (see [page 35](#)) (5)
- 11 GP – ENC slot for encoder interface module (see [page 34](#)) or additional I/O module (see [page 35](#))
- 12 GP – FB slot for communication option module (see [page 39](#)) or additional I/O module (see [page 35](#)) (6) or Sercos communication module (8)

(1) ATV340D30N4E to ATV340D75N4E references have 8 digital inputs (positive or negative logic), 1 assignable digital output, 3 analog inputs configurable as voltage or current, including 2 for probes (PTC, PT100, PT1000, or KTY84), 2 analog outputs configurable as voltage (0..10 V) or current (0-20 mA), and 3 relay outputs - 1 with NO/NC and 2 with NO contacts.

(2) ATV340D30N4E to ATV340D75N4E references: DC bus connection is possible but not located on the front of the product; for more details please refer to the [installation manual](#).

(3) ATV340D30N4E to ATV340D75N4E references require an encoder option module for closed loop operation.

(4) ATV340D30N4E to ATV340D75N4E references do not have PTI/PTO for master/slave operation. Drive-to-drive link via Ethernet or analog inputs and outputs can be used.

(5) ATV340D30N4E to ATV340D75N4E references have different option slot positions; for more details please refer to the [installation manual](#).

(6) ATV340●●●N4E references are equipped with dual port Ethernet IP/Modbus TCP communication, communication option modules can be inserted in ATV340D30N4E...D75N4E references. For more details please refer to the [installation manual](#).

(7) Not supported by Sercos drives.

(8) Sercos drives only.

Variable speed drives

Altivar Machine ATV340

Modular version

Three-phase supply voltage: 380...480 V 50/60 Hz



ATV340U22N4



ATV340U75N4



ATV340D22N4

Variable speed drives - Modular version (1)											
Motor	AC supply						Altivar Machine			Reference (1)	Weight
	Power indicated on rating plate (2)		Input current (3)		Apparent power	Prospective line Isc	Maximum continuous current (2)	Maximum transient current for 2 s	Maximum transient current for 60 s		
HD: Heavy duty (5)			380 V	480 V	480 V						
ND: Normal duty (4)											
	kW	HP	A	A	kVA	kA	A	A	A	kg/lb	
Three-phase supply voltage: 380...480 V 50/60 Hz											
HD	0.75	1	3.4	2.6	2.2	5	2.2	4	3.3	ATV340U07N4 / 1.700/3.748	
ND	1.1	1.5	2.6	2.1	1.7	5	2.8	3.8	3.1		
HD	1.5	2	6	4.9	4.1	5	4	7.2	6	ATV340U15N4 / 1.700/3.748	
ND	2.2	3	5.1	4.1	3.4	5	5.6	7.6	6.2		
HD	2.2	3	8.4	6.6	5.5	5	5.6	10.1	8.4	ATV340U22N4 / 1.800/3.968	
ND	3	3	6.6	5.3	4.4	5	7.2	9.7	7.9		
HD	3	3	10.7	8.5	7.1	5	7.2	13	10.8	ATV340U30N4 / 2.100/4.630	
ND	4	5	8.6	6.8	5.7	5	9.3	12.6	10.2		
HD	4	5	13.4	10.6	8.8	5	9.3	16.7	14	ATV340U40N4 / 2.200/4.850	
ND	5.5	7	11.4	9	7.5	5	12.7	17.1	14		
HD	5.5	7	20	16	13.3	22	12.7	22.9	19.1	ATV340U55N4 / 2.900/6.393	
ND	7.5	10	15.3	12.2	10.1	22	16.5	22.3	18.2		
HD	7.5	10	25.6	20.4	17	22	16.5	29.7	24.8	ATV340U75N4 / 3.000/6.614	
ND	11	15	22	17.7	14.7	22	24	32.4	26.4		
HD	11	15	34.7	27.7	23	22	24	43	36	ATV340D11N4 / 9.500/20.944	
ND	15	20	28.8	23	19.1	22	32	43	35.2		
HD	15	20	44.9	35.7	29.7	22	32	58	48	ATV340D15N4 / 9.500/20.944	
ND	18.5	25	37.4	30.2	25.1	22	39	53	42.9		
HD	18.5	25	54.7	43.4	36.1	22	39	70	59	ATV340D18N4 / 10.200/22.487	
ND	22	30	43.4	35	29.1	22	46	62	50.6		
HD	22	30	63.5	50.6	42.1	22	46	83	69	ATV340D22N4 / 10.200/22.487	
ND	30	40	60.1	48.6	40.4	22	62	84	68.2		

- (1) Altivar Machine **ATV340●●●N4** drives integrate a category C3 EMC filter with 20 m/66 ft shielded motor cable.
- (2) These values are given for a nominal switching frequency of 4 kHz up to **ATV340D22N4**, for use in continuous operation. The switching frequency is adjustable. Above 4 kHz, the drive will automatically reduce the switching frequency in the event of an excessive temperature rise. For continuous operation above the nominal switching frequency, derate the nominal drive current (see derating curves on our website www.schneider-electric.com).
- (3) Typical value for the indicated motor power and for the prospective line Isc.
- (4) For ATV340U07...D22N4● values given for applications requiring slight overload (up to 135% for 2 s and 110% for 60 s).
- (5) For ATV340U07...D22N4● values given for applications requiring significant overload (up to 180% for 2 s and 150% for 60 s).

Note: Drives are shown with optional plain text display, which can be ordered separately as an add-on. Consult the summary tables of possible drive, option, and accessories combinations (see [page 30](#)).

Ambient temperature range:

- For normal duty operation mode: ATV340U07...D22N4 -15...40 °C/5...104 °F without derating (up to 60 °C/140 °F with derating)
 - For heavy duty operation mode: ATV340U07...D22N4 -15...50 °C/5...122 °F without derating (up to 60 °C/140 °F with derating)
- For more details regarding the thermal capacity of references, please visit www.schneider-electric.com
- Transportation and storage temperature range for ATV340U07...D22N4 -40...70 °C/-40...158 °F in dry and dust-free environment.

Variable speed drives

Altivar Machine ATV340

Ethernet version

Three-phase supply voltage: 380...480 V 50/60 Hz



ATV340U22N4E



ATV340U75N4E



ATV340D22N4E



ATV340D37N4E

Variable speed drives - Ethernet version (1)										
Motor	AC supply						Altivar Machine			
Power indicated on rating plate (2)	Input current (3)		Apparent power	Prospective line Isc	Maximum continuous current (2)	Maximum transient current for 2 s	Maximum transient current for 60 s	Reference (1)	Weight	
	380 V	480 V								480 V
HD: Heavy duty (5)										
ND: Normal duty (4)										
kW	HP	A	A	kVA	kA	A	A	A	kg/lb	
Three-phase supply voltage: 380...480 V 50/60 Hz										
HD 0.75	1	3.4	2.6	2.2	5	2.2	4	3.3	ATV340U07N4E	1.700/3.748
ND 1.1	1.5	2.6	2.1	1.7	5	2.8	3.8	3.1		
HD 1.5	2	6	4.9	4.1	5	4	7.2	6	ATV340U15N4E	1.700/3.748
ND 2.2	3	5.1	4.1	3.4	5	5.6	7.6	6.2		
HD 2.2	3	8.4	6.6	5.5	5	5.6	10.1	8.4	ATV340U22N4E	1.800/3.968
ND 3	3	6.6	5.3	4.4	5	7.2	9.7	7.9		
HD 3	3	10.7	8.5	7.1	5	7.2	13	10.8	ATV340U30N4E	2.100/4.630
ND 4	5	8.6	6.8	5.7	5	9.3	12.6	10.2		
HD 4	5	13.4	10.6	8.8	5	9.3	16.7	14	ATV340U40N4E	2.200/4.850
ND 5.5	7	11.4	9	7.5	5	12.7	17.1	14		
HD 5.5	7	20	16	13.3	22	12.7	22.9	19.1	ATV340U55N4E	2.900/6.393
ND 7.5	10	15.3	12.2	10.1	22	16.5	22.3	18.2		
HD 7.5	10	25.6	20.4	17	22	16.5	29.7	24.8	ATV340U75N4E	3.000/6.614
ND 11	15	22	17.7	14.7	22	24	32.4	26.4		
HD 11	15	34.7	27.7	23	22	24	43	36	ATV340D11N4E	9.500/20.944
ND 15	20	28.8	23	19.1	22	32	43	35.2		
HD 15	20	44.9	35.7	29.7	22	32	58	48	ATV340D15N4E	9.500/20.944
ND 18.5	25	37.4	30.2	25.1	22	39	53	42.9		
HD 18.5	25	54.7	43.4	36.1	22	39	70	59	ATV340D18N4E	10.200/22.487
ND 22	30	43.4	35	29.1	22	46	62	50.6		
HD 22	30	63.5	50.6	42.1	22	46	83	69	ATV340D22N4E	10.200/22.487
ND 30	40	60.1	48.6	40.4	22	62	84	68.2		
HD 30	40	54.8	48.3	40.2	50	61.5	92.25	92.25	ATV340D30N4E	27.900/61.509
ND 37	50	66.2	57.3	47.6	50	74.5	89.4	89.4		
HD 37	50	67.1	59	49.1	50	74.5	111.75	111.75	ATV340D37N4E	28.400/62.611
ND 45	60	79.8	69.1	57.4	50	88	105.6	105.6		
HD 45	60	81.4	71.8	59.7	50	88	132	132	ATV340D45N4E	56.400/124.341
ND 55	75	97.2	84.2	70	50	106	127.2	127.2		
HD 55	75	98.9	86.9	72.2	50	106	159	159	ATV340D55N4E	57.900/127.648
ND 75	100	131.3	112.7	93.7	50	145	174	174		
HD 75	100	134.3	118.1	98.2	50	145	217.5	217.5	ATV340D75N4E	58.400/128.750
ND 90	125	156.2	135.8	112.9	50	173	207.6	207.6		

- (1) Altivar Machine ATV340U07...D22N4E drives integrate a category C3 EMC filter with 20 m/66 ft shielded motor cable. ATV340D30...D37N4E drives integrate a category C2 EMC filter with 50 m/164 ft motor cable and category C3 EMC filter with 150 m/492 ft motor cable. ATV340D45...D75N4E drives integrate a category C3 EMC filter with 150 m/492 ft shielded motor cable.
- (2) These values are given for a nominal switching frequency of 4 kHz up to **ATV340D37N4E** (2.5 kHz for **ATV340D45N4E...ATV340D75N4E**), for use in continuous operation. The switching frequency is adjustable. Above 2.5 or 4 kHz (depending on the rating), the drive will automatically reduce the switching frequency in the event of an excessive temperature rise. For continuous operation above the nominal switching frequency, derate the nominal drive current (see derating curves on our website www.schneider-electric.com).
- (3) Typical value for the indicated motor power and for the prospective line Isc.
- (4) For ATV340U07...D22N4E values given for applications requiring slight overload (up to 135% for 2 s and 110% for 60 s). For ATV340D30...D75N4E values given for applications requiring slight overload (up to 110% for 60 s).
- (5) For ATV340U07...D22N4E values given for applications requiring significant overload (up to 180% for 2 s and 150% for 60 s). For ATV340D30...D75N4E values given for applications requiring significant overload (up to 150% for 60 s).

Note: Drives are shown with optional plain text display, which can be ordered separately as an add-on. Consult the summary tables of possible drive, option, and accessory combinations (see [page 30](#)).

Ambient temperature range:

■ For normal duty operation mode:

- ATV340U07...D22N4E -15...40 °C/5...104 °F without derating (up to 60 °C/140 °F with derating)
- ATV340D30...D75N4E -15...50 °C/5...122 °F without derating (up to 60 °C/140 °F with derating)

■ For heavy duty operation mode:

- ATV340U07...D22N4E -15...50 °C/5...122 °F without derating (up to 60 °C/140 °F with derating)
- ATV340D30...D75N4E -15...50 °C/5...122 °F without derating (up to 60 °C/140 °F with derating)

For more details regarding the thermal capacity of references, please visit www.schneider-electric.com

■ Transportation and storage temperature range for ATV340U07...D75N4E -40...70 °C/-40...158 °F in dry and dust-free environment.

Variable speed drives

Altivar Machine ATV340

Sercos version

Three-phase supply voltage: 380...480 V 50/60 Hz



ATV340U22N4S



ATV340U75N4S



ATV340D22N4S

Variable speed drives - Sercos version (1)										
Motor	AC supply					Altivar Machine			Reference (1)	Weight
	Power indicated on rating plate (2)	Input current (3)		Apparent power	Prospective line Isc	Maximum continuous current (2)	Maximum transient current for 2 s	Maximum transient current for 60 s		
HD: Heavy duty (5)	380 V	480 V	480 V						A	A
ND: Normal duty (4)	kW	HP	A	A	kVA	kA	A	A	A	kg/lb
Three-phase supply voltage: 380...480 V 50/60 Hz										
HD	0.75	1	3.4	2.6	2.2	5	2.2	4	3.3	ATV340U07N4S 1.700/3.748
ND	1.1	1.5	2.6	2.1	1.7	5	2.8	3.8	3.1	
HD	1.5	2	6	4.9	4.1	5	4	7.2	6	ATV340U15N4S 1.700/3.748
ND	2.2	3	5.1	4.1	3.4	5	5.6	7.6	6.2	
HD	2.2	3	8.4	6.6	5.5	5	5.6	10.1	8.4	ATV340U22N4S 1.800/3.968
ND	3	3	6.6	5.3	4.4	5	7.2	9.7	7.9	
HD	3	3	10.7	8.5	7.1	5	7.2	13	10.8	ATV340U30N4S 2.100/4.630
ND	4	5	8.6	6.8	5.7	5	9.3	12.6	10.2	
HD	4	5	13.4	10.6	8.8	5	9.3	16.7	14	ATV340U40N4S 2.200/4.850
ND	5.5	7	11.4	9	7.5	5	12.7	17.1	14	
HD	5.5	7	20	16	13.3	22	12.7	22.9	19.1	ATV340U55N4S 2.900/6.393
ND	7.5	10	15.3	12.2	10.1	22	16.5	22.3	18.2	
HD	7.5	10	25.6	20.4	17	22	16.5	29.7	24.8	ATV340U75N4S 3.000/6.614
ND	11	15	22	17.7	14.7	22	24	32.4	26.4	
HD	11	15	34.7	27.7	23	22	24	43	36	ATV340D11N4S 9.500/20.944
ND	15	20	28.8	23	19.1	22	32	43	35.2	
HD	15	20	44.9	35.7	29.7	22	32	58	48	ATV340D15N4S 9.500/20.944
ND	18.5	25	37.4	30.2	25.1	22	39	53	42.9	
HD	18.5	25	54.7	43.4	36.1	22	39	70	59	ATV340D18N4S 10.200/22.487
ND	22	30	43.4	35	29.1	22	46	62	50.6	
HD	22	30	63.5	50.6	42.1	22	46	83	69	ATV340D22N4S 10.200/22.487
ND	30	40	60.1	48.6	40.4	22	62	84	68.2	

- (1) Altivar Machine ATV340U07...D22N4S drives integrate a category C3 EMC filter with 20 m/66 ft shielded motor cable.
- (2) These values are given for a nominal switching frequency of 4 kHz for use in continuous operation. The switching frequency is adjustable. Above 4 kHz, the drive will automatically reduce the switching frequency in the event of an excessive temperature rise. For continuous operation above the nominal switching frequency, derate the nominal drive current (see derating curves on our website www.schneider-electric.com).
- (3) Typical value for the indicated motor power and for the prospective line Isc.
- (4) For ATV340U07...D22N4S values given for applications requiring slight overload (up to 135% for 2 s and 110% for 60 s).
- (5) For ATV340U07...D22N4S values given for applications requiring significant overload (up to 180% for 2 s and 150% for 60 s).

Note: Drives are shown with optional plain text display, which can be ordered separately as an add-on. Consult the summary tables of possible drive, option, and accessory combinations (see page 30).

Ambient temperature range:

- For normal duty operation mode:
 - ATV340U07...D22N4S -15...40 °C/5...104 °F without derating (up to 60 °C/140 °F with derating)
- For heavy duty operation mode:
 - ATV340U07...D22N4S -15...50 °C/5...122 °F without derating (up to 60 °C/140 °F with derating)

For more details regarding the thermal capacity of references, please visit www.schneider-electric.com

- Transportation and storage temperature range for ATV340U07...D75N4S -40...70 °C/-40...158 °F in dry and dust-free environment.

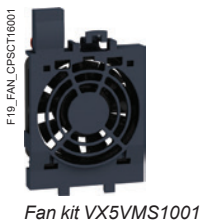
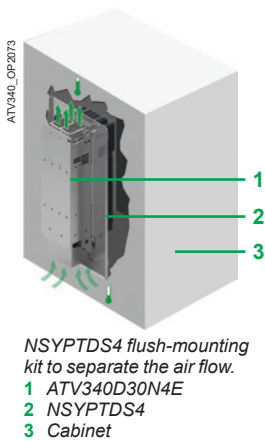
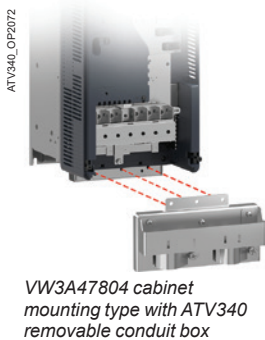

Mounting accessories

Description	Corresponding drive	Reference	Weight kg/lb
Plate for EMC mounting	ATV340U07N4...U40N4	VW3A4430	0.292/ 0.644
	ATV340U55N4...U75N4	VW3A4431	0.320/ 0.705
	ATV340D11N4...D22N4	VW3A4432	0.423/ 0.933
	ATV340D30N4E...D37N4E	VW3A47804	1.000/ 2.205
	ATV340D45N4E...D75N4E	VW3A47805	1.670/ 3.682
	Flush-mounting kit for separate air flow For mounting the drive power section outside the enclosure This contains: ■ Fixing accessories ■ 1 metal frame ■ Screws and seals ■ 1 user manual	ATV340D11N4...D22N4	VW3M2606
	ATV340D30N4E...D37N4E	NSYPTDS4	8.102/ 17.862
	ATV340D45N4E...D75N4E	NSYPTDS5	11.086/ 24.440

Connection accessories

Daisy chain connection of the DC bus (1)

The DC bus can be connected in a daisy chain in the following cases:

- Drives powered by the AC supply with parallel connection of the DC bus in order to balance the loads during braking phases between the drives; used in addition to braking resistors (see page 44)
- Drives powered by the DC bus only

This requires the connection accessories listed below:

Description	Use between	Length m/ft	Sold in lots of	Reference	Weight kg/lb
Cordset (1) equipped with 2 connectors	ATV340U07...U75N4	0.18/	5	VW3M7101R01	-
	ATV340U07...U75N4E	0.59			
	ATV340U07...D22N4S				
Shielded cable	ATV340U07...U75N4	15/	1	VW3M7102R150	-
	ATV340U07...U75N4E	49			
	ATV340U07...D22N4S				
Connection kit for VW3M7102R150 cable	-	-	10	VW3M2207	-
Daisy chain connection or pulse control	Equipped with 2 RJ45 connectors	0.3/	1	VW3M8502R03	0.025/ 0.055
		0.98			
	Equipped with 1 RJ45 connector and a free end	1.5/ 4.92	1	VW3M8502R15	0.062/ 0.137
		3/ 9.84	1	VW3M8223R30	0.500/ 1.102

Replacement parts

Description	Corresponding drive	Reference	Weight kg/lb
Fan kit			
Power fan for IP21 drives, bracket, instruction sheets	ATV340U07N4...U40N4	VX5VMS1001	-
	ATV340U55N4...U75N4	VX5VMS2001	-
	ATV340D11N4...D22N4	VX5VMS3001	-
	ATV340D30N4E...D37N4E	VX5VPS4001	-
	ATV340D45N4E...D75N4E	VX5VPS5001	-
	Connector kit for I/O, motor, and power connection	ATV340U07N4...U40N4	VW3A34001
	ATV340U55N4...U75N4	VW3A34002	-
	ATV340D11N4...D22N4	VW3A34003	-

(1) For more details on DC bus sharing applications, please consult our Customer Care Center.

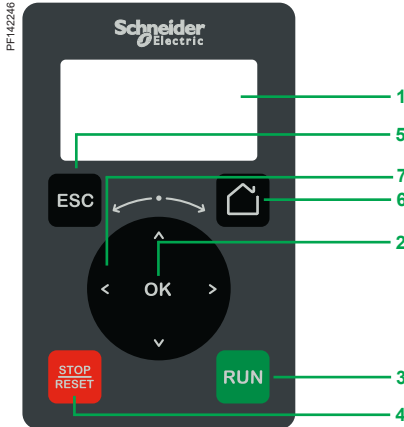

Plain text display terminal

Plain text display terminal

The plain text display terminal can be ordered separately, and can be:

- Connected and mounted on the front of the drive
- Connected and mounted on an enclosure door using a remote-mounting accessory

This terminal is used to:

- Control, adjust, and configure the drive
- Display current values (motor, I/O, and machine data)
- Store and download configurations (several configuration files can be stored in the memory)
- Duplicate the configuration of one powered-up drive on another powered-up drive

Other features:

- Displaying the device - via Web server and password; a display terminal is required to log in to the Web server for the first time
- Realtime clock providing data acquisition and event time-stamping functions
- 2 lines
- Languages (Chinese, English, French, German, Italian, Spanish)
- White backlit LCD screen
- Operating range: -15...50 °C/+5...122 °F
- IP21 protection
- Removable, easy plug-in with RJ45 port

Description

The front of the display terminal comprises:

- 1 LCD backlight screen
- 2 OK button: saves the current value (ENT)
- 3 RUN button: local control of motor run command
- 4 STOP/RESET button: local control of motor stop command/clearing detected errors
- 5 ESC button: aborts a value, parameter, or menu to return to the previous selection
- 6 Home: root menu
- 7 Turn ±: navigation dial, increases or decreases the value, goes to the next or previous line

References

Description	Reference	Weight kg/ lb
Plain text display terminal	VW3A1113	0.200/ 0.441

PF142222

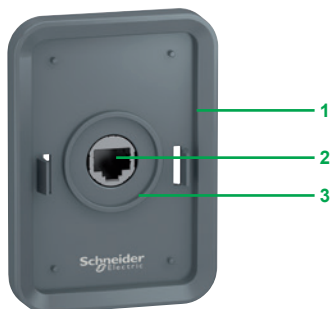

Remote-mounting kit for mounting plain text display terminal on enclosure door (front panel)

PF142251



Remote-mounting kit for mounting plain text display terminal on enclosure door (rear panel)

Mounting kit for plain text display terminal

■ Remote-mounting kit for mounting on an enclosure door with IP43 degree of protection as standard

Description

The kit comprises:

- Tightening tool (also sold separately under the reference ZB5AZ905)

- 1 Mounting plate
- 2 RJ45 port for the plain text display terminal
- 3 Seal
- 4 Fixing nut
- 5 RJ45 port for connecting the remote-mounting cordset

Cordsets should be ordered separately depending on the length required.

Drilling a hole with a standard $\varnothing 22$ tool, as used for a pushbutton, allows the unit to be mounted without the need for a cut-out in the enclosure ($\varnothing 22.5$ mm/ $\varnothing 0.89$ in. drill hole).

An anti-rotation function is provided that works as follows: when the kit is locked tightly onto the panel by the nut, the gasket on the back cannot rotate.

References

Description	Length m/ ft	IP degree of protection	Reference	Weight kg/ lb
Remote-mounting kit Order with remote-mounting cordset VW3A1104R●●●	–	43	VW3A1114	–
Tightening tool for remote-mounting kit	–	–	ZB5AZ905	0.016/ 0.035
Remote-mounting cordset equipped with 2 RJ45 connectors	1/ 3.28	–	VW3A1104R10	0.050/ 0.110
	3/ 9.84	–	VW3A1104R30	0.150/ 0.331
	5/ 16.4	–	VW3A1104R50	0.250/ 0.551
	10/ 32.8	–	VW3A1104R100	0.500/ 1.102



Graphic display terminal
VW3A1111



Detected fault: The
screen's red backlight is
activated automatically



Example of multipoint screen architecture



Embedded dynamic QR
codes for contextual,
instantaneous access to
online help



Scanning the QR code
from a smartphone or tablet



Instant access to online help

Graphic display terminal

This terminal can be:

- Connected and mounted on an enclosure door using a remote-mounting accessory
- Connected to a PC to exchange files via a Mini USB/USB connection (1)
- Connected to several drives in multipoint mode (see page 37)

This terminal is used to:

- Control, adjust, and configure the drive
- Display current values (motor, I/O, and machine data)
- Display graphic dashboards such as the energy consumption monitoring dashboard
- Store and download configurations (several configuration files can be stored in the 16 MB memory)
- Duplicate the configuration of one powered-up drive on another powered-up drive
- Copy configurations from a PC or drive and duplicate them on another drive (the drives should be powered up throughout the duplication operations)

Other characteristics:

- Up to 24 languages (complete alphabets) covering the majority of countries around the world (languages can be removed, added and updated according to user needs; please consult our website www.schneider-electric.com)
- 2-color backlit display (white and red); if an error is detected, the red backlight is activated automatically (function can be disabled)
- Operating range: -15...50 °C/+5...122 °F
- Degree of protection: IP65
- Trend curves: Graphic display of changes over time in monitoring variables, energy data, and machine data
- Realtime clock with 10-year backup battery providing data acquisition and event time-stamping functions even when the drive is stopped

Multipoint screen

The graphic display terminal is connected to one drive only. However, communication is possible between a graphic display terminal and several Altivar drives (ATV340, ATV600, and ATV900) connected on the same Modbus serial fieldbus via the RJ45 port (HMI or Modbus serial). In this case, multipoint mode is automatically applied to the graphic display terminal.

A maximum of 32 drives can be connected on the same Modbus serial fieldbus.

Apart from the Stop function linked to the STOP/RESET key, multipoint mode cannot be used to apply a reset after a fault has been detected or control the drive via the graphic display terminal: in multipoint mode, the Run key and the Local/Remote key are disabled.

Description

Display:

- 8 lines, 240 x 160 pixels
- Displays bar charts, gages, and trend charts
- 4 function keys to facilitate navigation and provide contextual links for enabling functions
- STOP/RESET button: Local control of motor stop command/clearing detected errors
- RUN button: Local control of motor run command
- Navigation buttons:
 - OK button: Saves the current value (ENT)
 - Turn ±: Increases or decreases the value, goes to the next or previous line
 - ESC button: Aborts a value, parameter, or menu to return to the previous selection
 - Home: Root menu
 - Information (i): Contextual help

References

Description	Reference	Weight kg/ lb
Graphic display terminal	VW3A1111	0.200/ 0.441

(1) Graphic display terminal used only as a handheld terminal.

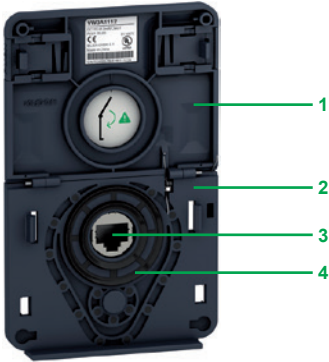

Remote-mounting kit for mounting graphic display terminal on enclosure door (front panel)

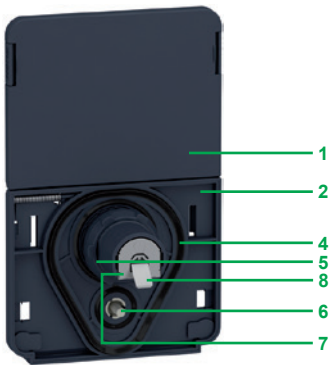

Remote-mounting kit for graphic display terminal (rear panel)

Accessories for graphic display terminal

- Remote-mounting kit for mounting on enclosure door with IP65/UL Type 12 degree of protection as standard

The kit comprises:

- Tightening tool (also sold separately under the reference ZB5AZ905)

- Cover plate to maintain IP65 protection when there is no terminal connected
- Mounting plate
- RJ45 port for the graphic display terminal
- Seal
- Fixing nut
- Anti-rotation pin
- RJ45 port for connecting the remote-mounting cordset (10 m/32.8 ft maximum)
Cordsets should be ordered separately depending on the length required.
- Grounding connector

Drilling a hole with a standard $\varnothing 22$ tool, as used for a pushbutton, allows the unit to be mounted without the need for a cut-out in the enclosure ($\varnothing 22.5$ mm/ $\varnothing 0.89$ in. drill hole).

References

Description	Length m/ ft	IP	Reference	Weight kg/ lb
Remote-mounting kit Order with remote-mounting cordset VW3A1104R●●●	–	65/UL Type 12	VW3A1112	–
Tightening tool for remote-mounting kit	–	–	ZB5AZ905	0.016/ 0.035
Remote-mounting cordset equipped with 2 RJ45 connectors	1/ 3.28	–	VW3A1104R10	0.050/ 0.110
	3/ 9.84	–	VW3A1104R30	0.150/ 0.331
	5/ 16.4	–	VW3A1104R50	0.250/ 0.551
	10/ 32.8	–	VW3A1104R100	0.500/ 1.102
	–	65	VW3A1115	0.200/ 0.441
IP65 remote-mounting kit for Ethernet port (1) $\varnothing 22$ RJ45 female/female adapter with seal	–	65	VW3A1115	0.200/ 0.441

Configuration tools

Connection accessories

Description	Reference	Weight kg/ lb
SoMove setup software For configuring, adjusting, and debugging the Altivar Machine drive	(2)	–
USB/RJ45 cable equipped with a USB connector and an RJ45 connector. For connecting a PC to the drive. Length: 2.5 m/8.2 ft	TCSMCNAM3M002P	–

Communication accessories

Description	Reference	Weight kg/ lb
IP20 WiFi dongle Remote mounting of the Ethernet port for connecting WiFi equipment (PC, tablet, smartphone, etc.) powered by internal rechargeable battery	TCSEGWB13FA0	0.350/ 0.772
Modbus/Uni-Telway-Bluetooth® adapter For establishing a Bluetooth® wireless connection between drive and PC equipped with a Bluetooth® wireless link. Pack contents: <ul style="list-style-type: none"> 1 Bluetooth® adapter (range 20 m/66 ft, class 2) with an RJ45 connector For SoMove: 1 x 0.1 m/0.33 ft cordset with 2 RJ 45 connectors (3) 	TCSWAAC13FB	0.032/ 0.071
USB - Bluetooth® adapter for PC Required for a PC that is not equipped with Bluetooth® technology. Connects to a USB port on the PC. Range of 10 m/32.8 ft (class 2).	VW3A8115	0.200/ 0.441

(1) Used to connect a remote PC to the RJ45 port on an IP21 drive mounted in an enclosure or on a wall. Drill hole with a standard $\varnothing 22$ tool, as used for a pushbutton. (Requires remote-mounting cordset VW3A1104R●●● equipped with 2 RJ45 connectors).

(2) See page 29.

(3) Also includes other components for connecting compatible Schneider Electric devices.

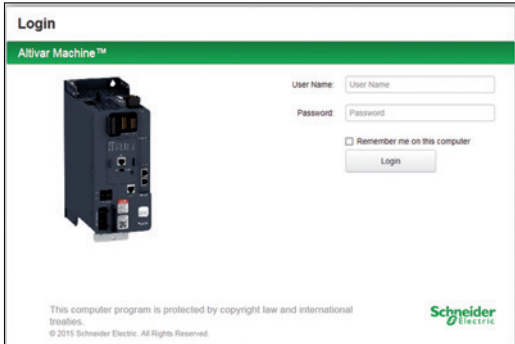

Login screen

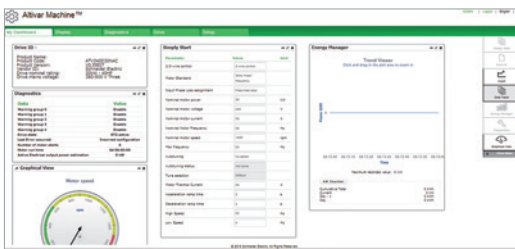

Customizable widgets



Drive parameters tab

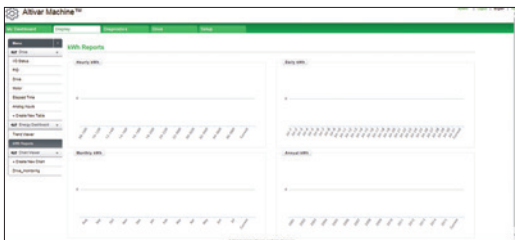

Energy dashboard

Web server

Presentation

- The Web server can only be accessed via an Ethernet-embedded drive ATV340●●●N4E
- Connection of a drive that is not a part of an Ethernet network
 - Wired connection via an Ethernet cable using the drive Ethernet port
 - Wireless connection via Schneider Electric WiFi dongle
- Connection of a drive that is part of an Ethernet network
 - From any point on the network by entering the drive IP address

- The Web server is used for:
 - Commissioning the drive (setting configuration parameters and enabling the main functions)
 - Monitoring energy and machine data, as well as drive and motor data
 - Diagnostics (drive status, file transfer, detected error and warning logs)

Description

The Web server is structured around five tabs.

- “My dashboard” tab:
 - Configurable using a wide range of widgets; groups the information and dashboards selected by the user together on one page
 - Graphics, charts, and monitoring tables can be customized to provide a user-friendly interface
- “Display” tab:
 - Monitors energy indicators, efficiency, and performance
 - Displays time-stamped application data such as motor current or temperature
 - Monitors drive parameters and status
 - Shows the I/O state and assignment
- “Diagnostics” tab:
 - Drive status
 - Time and date-stamped warning and detected error logs
 - Network diagnostics
 - Access to drive self-tests
- “Drive” tab:
 - Viewing the main drive parameters
 - Editing the main drive parameters
- “Setup” tab:
 - Network configuration
 - Access management
 - Transferring and retrieving drive configurations
 - Exporting data acquisition files and logs
 - Customizing pages (colors, logos, etc.)

Other characteristics:

- Ease of connection via the RJ45 port or WiFi connection
- Password-protected authentication (modifiable password; access rights can be configured by administrator)
- No specific tool required or installation necessary, just connect to the Web browser from a drive (using standard Ethernet cable or WiFi dongle)
- Web server can be disabled
- Works in a similar way on PCs, iPhones, iPads, Android systems, and the major Web browsers:
 - Internet Explorer® (version 8 or higher)
 - Google Chrome® (version 11 or higher)
 - Mozilla Firefox® (version 4 or higher)
 - Safari® (version 5.1.7 or higher)

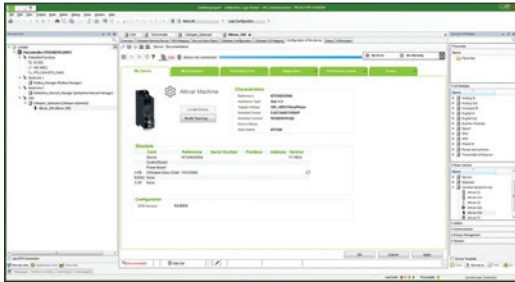

Altivar Machine DTM in EcoStruxure Machine Expert



SoMove software

Safety function transfer and configuration

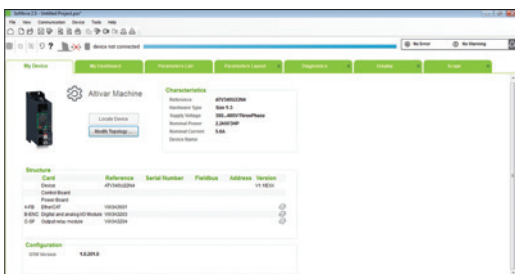

Altivar Machine in SoMove



SoMove software

DTM

Presentation

Using FDT/DTM technology it is possible to configure, control, and diagnose Altivar Machine drives directly in EcoStruxure Machine Expert and SoMove software by means of the same software brick (DTM).

FDT/DTM technology standardizes the communication interface between field devices and host systems. The DTM contains a uniform structure for managing drive access parameters.

Specific functions of the Altivar Machine DTM

- Offline or online access to drive data
- Transferring configuration files from and to the drive
- Customization (dashboard, My Menu, etc.)
- Access to drive parameters and option cards
- Oscilloscope function
- Energy and application data dashboards
- Detected error and warning logs (with time-stamping)
- Configuration, transfer, and monitoring of the Safety functions

Advantages of the DTM in EcoStruxure Machine Expert:

- Single tool for configuration, setup, and diagnostics
- Network scan for automatic recognition of network configuration in Ethernet architectures (1)
- Ability to add/remove, copy/paste configuration files from other drives in the same architecture
- Single input point for all parameters shared between the PLC (programmable logic controller) and the Altivar Machine drives
- Creation of drive profiles for implicit communication with the PLC as well as dedicated profiles for programs with DFBs (derived function blocks)
- Integration in the fieldbus topology
- Drive configuration is an integral part of the EcoStruxure Machine Expert project file
- Application function block for EcoStruxure Machine Expert PLC
- Display visualization blocks for Vijeo Designer

Advantages of the DTM in SoMove:

- Drive-oriented software environment
- Wired connection to the Ethernet communication port
- Standard cable (file transfer performance)

■ Third-party software and downloads:

The Altivar Machine ATV340 DTM is a flexible, open, and interactive tool that can be used in a third-party FDT.

DTMs can be downloaded from our website www.schneider-electric.com.

SoMove software

Presentation

SoMove software for PC is used to configure, set up, and maintain Altivar Machine drives.

In addition to the functions offered by the Web server, SoMove software features the oscilloscope function for accurate display of data samples, as well as access to multi-drive applications.

The software can be connected to Altivar Machine ATV340 variable speed drives via:

- A direct USB/RJ45 cable (Modbus serial) link
- A Bluetooth® wireless connection with the Bluetooth/Modbus adapter **TCSWAAC13FB**
- Ethernet Modbus and WiFi connection with the WiFi dongle **TCSEGWB13FA0**
- Ethernet Modbus TCP connection

For ATV340 Sercos drives, DTM is used with SoMove over Modbus Serial line only. For more information on SoMove setup software, please refer to the "[SoMove: Setup Software](#)" catalog.

(1) Only applicable for ATV340 Ethernet drives, ATV340●●●N4E.

Combinations of options for Altivar Machine 340 drives													
Motor		Motor		Drive	Accessories		Options			Line AC chokes	dv/dt output filters	EMC input filters	Regenerative unit
Heavy duty		Normal duty			EMC kit	Push-through flush mounting kit	Braking resistors						
kW	HP	kW	HP				Light cycle	Medium cycle	Severe cycle				
Three-phase supply voltage: 380...480 V 50/60 Hz - Modular drive													
0.75	1	1.1	1.5	ATV340U07N4	VW3A4430	–	VW3A7730	VW3A7740	VW3A7750	VW3A4551	VW3A5301	VW3A4422	ATVRU75N4
1.5	2	2.2	3	ATV340U15N4	VW3A4430	–	VW3A7730	VW3A7740	VW3A7750	VW3A4551	VW3A5301	VW3A4422	ATVRU75N4
2.2	3	3	3	ATV340U22N4	VW3A4430	–	VW3A7730	VW3A7740	VW3A7750	VW3A4552	VW3A5302	VW3A4423	ATVRU75N4
3	3	4	5	ATV340U30N4	VW3A4430	–	VW3A7730	VW3A7740	VW3A7750	VW3A4552	VW3A5302	VW3A4423	ATVRU75N4
4	5	5.5	7	ATV340U40N4	VW3A4430	–	VW3A7731	VW3A7741	VW3A7751	VW3A4552	VW3A5302	VW3A4423	ATVRU75N4
5.5	7	7.5	10	ATV340U55N4	VW3A4431	–	VW3A7731	VW3A7741	VW3A7751	VW3A4553	VW3A5303	VW3A4423	ATVRU75N4
7.5	10	11	15	ATV340U75N4	VW3A4431	–	VW3A7732	VW3A7742	VW3A7752	VW3A4553	VW3A5303	VW3A4423	ATVRU75N4
11	15	15	20	ATV340D11N4	VW3A4432	VW3M2606	VW3A7732	VW3A7742	VW3A7752	VW3A4554	VW3A5304	VW3A4711	ATVRD15N4
15	20	18.5	25	ATV340D15N4	VW3A4432	VW3M2606	VW3A7733	VW3A7743	VW3A7753	VW3A4554	VW3A5304	VW3A4712	ATVRD15N4
18	25	22	30	ATV340D18N4	VW3A4432	VW3M2606	VW3A7733	VW3A7743	VW3A7753	VW3A4555	VW3A5304	VW3A4712	ATVRD15N4
22	30	30	40	ATV340D22N4	VW3A4432	VW3M2606	VW3A7733	VW3A7743	VW3A7753	VW3A4555	VW3A5305	VW3A4712	ATVRD15N4
Three-phase supply voltage: 380...480 V 50/60 Hz - Ethernet drive													
0.75	1	1.1	1.5	ATV340U07N4E	VW3A4430	–	VW3A7730	VW3A7740	VW3A7750	VW3A4551	VW3A5301	VW3A4422	ATVRU75N4
1.5	2	2.2	3	ATV340U15N4E	VW3A4430	–	VW3A7730	VW3A7740	VW3A7750	VW3A4551	VW3A5301	VW3A4422	ATVRU75N4
2.2	3	3	3	ATV340U22N4E	VW3A4430	–	VW3A7730	VW3A7740	VW3A7750	VW3A4552	VW3A5302	VW3A4423	ATVRU75N4
3	3	4	5	ATV340U30N4E	VW3A4430	–	VW3A7730	VW3A7740	VW3A7750	VW3A4552	VW3A5302	VW3A4423	ATVRU75N4
4	5	5.5	7	ATV340U40N4E	VW3A4430	–	VW3A7731	VW3A7741	VW3A7751	VW3A4552	VW3A5302	VW3A4423	ATVRU75N4
5.5	7	7.5	10	ATV340U55N4E	VW3A4431	–	VW3A7731	VW3A7741	VW3A7751	VW3A4553	VW3A5303	VW3A4423	ATVRU75N4
7.5	10	11	15	ATV340U75N4E	VW3A4431	–	VW3A7732	VW3A7742	VW3A7752	VW3A4553	VW3A5303	VW3A4423	ATVRU75N4
11	15	15	20	ATV340D11N4E	VW3A4432	VW3M2606	VW3A7732	VW3A7742	VW3A7752	VW3A4554	VW3A5304	VW3A4711	ATVRD15N4
15	20	18.5	25	ATV340D15N4E	VW3A4432	VW3M2606	VW3A7733	VW3A7743	VW3A7753	VW3A4554	VW3A5304	VW3A4711	ATVRD15N4
18	25	22	30	ATV340D18N4E	VW3A4432	VW3M2606	VW3A7733	VW3A7743	VW3A7753	VW3A4555	VW3A5304	VW3A4712	ATVRD15N4
22	30	30	40	ATV340D22N4E	VW3A4432	VW3M2606	VW3A7733	VW3A7743	VW3A7753	VW3A4555	VW3A5305	VW3A4712	ATVRD15N4
30	40	37	50	ATV340D30N4E	–	NSYPTDS4	VW3A7734	VW3A7744	VW3A7754	–	VW3A5305	VW3A4706	ATVRD15N4
37	50	45	60	ATV340D37N4E	–	NSYPTDS4	VW3A7734	VW3A7744	VW3A7754	–	VW3A5305	VW3A4706	ATVRD15N4
45	60	55	75	ATV340D45N4E	–	NSYPTDS5	VW3A7735	VW3A7745	VW3A7755	–	VW3A5306	VW3A4707	ATVRD15N4
55	75	75	100	ATV340D55N4E	–	NSYPTDS5	VW3A7736	VW3A7746	VW3A7756	–	VW3A5306	VW3A4708	ATVRD15N4
75	100	90	125	ATV340D75N4E	–	NSYPTDS5	VW3A7736	VW3A7746	VW3A7756	–	VW3A5306	VW3A4708	ATVRD15N4
Three-phase supply voltage: 380...480 V 50/60 Hz - Sercos drive													
0.75	1	1.1	1.5	ATV340U07N4S	VW3A4430	–	VW3A7730	VW3A7740	VW3A7750	VW3A4551	VW3A5301	VW3A4422	ATVRU75N4
1.5	2	2.2	3	ATV340U15N4S	VW3A4430	–	VW3A7730	VW3A7740	VW3A7750	VW3A4551	VW3A5301	VW3A4422	ATVRU75N4
2.2	3	3	3	ATV340U22N4S	VW3A4430	–	VW3A7730	VW3A7740	VW3A7750	VW3A4552	VW3A5302	VW3A4423	ATVRU75N4
3	3	4	5	ATV340U30N4S	VW3A4430	–	VW3A7730	VW3A7740	VW3A7750	VW3A4552	VW3A5302	VW3A4423	ATVRU75N4
4	5	5.5	7	ATV340U40N4S	VW3A4430	–	VW3A7731	VW3A7741	VW3A7751	VW3A4552	VW3A5302	VW3A4423	ATVRU75N4
5.5	7	7.5	10	ATV340U55N4S	VW3A4431	–	VW3A7731	VW3A7741	VW3A7751	VW3A4553	VW3A5303	VW3A4423	ATVRU75N4
7.5	10	11	15	ATV340U75N4S	VW3A4431	–	VW3A7732	VW3A7742	VW3A7752	VW3A4553	VW3A5303	VW3A4423	ATVRU75N4
11	15	15	20	ATV340D11N4S	VW3A4432	VW3M2606	VW3A7732	VW3A7742	VW3A7752	VW3A4554	VW3A5304	VW3A4711	ATVRD15N4
15	20	18.5	25	ATV340D15N4S	VW3A4432	VW3M2606	VW3A7733	VW3A7743	VW3A7753	VW3A4554	VW3A5304	VW3A4711	ATVRD15N4
18	25	22	30	ATV340D18N4S	VW3A4432	VW3M2606	VW3A7733	VW3A7743	VW3A7753	VW3A4555	VW3A5304	VW3A4712	ATVRD15N4
22	30	30	40	ATV340D22N4S	VW3A4432	VW3M2606	VW3A7733	VW3A7743	VW3A7753	VW3A4555	VW3A5305	VW3A4712	ATVRD15N4
Pages	20		23		23		44	45	45	48	50	46	52

Additional I/O modules		
Description	Reference	Page
Extended I/O module	VW3A3203	35
Extended relay module	VW3A3204	35

Encoder interface modules		
Description	Reference	Page
Digital interface encoder module	VW3A3420	34
Analog interface encoder module	VW3A3422	34
Resolver interface module	VW3A3423	34
HTL encoder interface module	VW3A3424	34

List of fieldbus modules		
Description	Reference	Page
CANopen daisy chain	VW3A3608	39
CANopen SUB-D	VW3A3618	39
CANopen screw terminal block	VW3A3628	40
PROFINET	VW3A3627	41
PROFIBUS DP V1	VW3A3607	41
DeviceNet	VW3A3609	41
POWERLINK communication module	VW3A3619	41
EtherCAT 2 x RJ45 communication module	VW3A3601	41

Module compatibility table			
Module type (1)	Modular, Ethernet, and Sercos drives GP-SF slot SlotC (2)	Modular, Ethernet, and Sercos drives GP-ENC SlotB (2)	Modular drive GP-FB slot SlotA (2)
Extended I/O VW3A3203			
Extended relay VW3A3204			
Fieldbuses VW3A3608, VW3A3618, VW3A3628, VW3A3607, VW3A3609, VW3A3601, VW3A3619, and VW3A3627			
Encoder interface modules VW3A3420, VW3A3422, VW3A3423, and VW3A3424			

Combination possible

Combination impossible

(1) Two modules of the same type cannot be inserted in the Altivar Machine ATV340 variable speed drives simultaneously.
 (2) SlotA, SlotB, and SlotC are the markings on the ATV340D30...D75N4E drives.



Embedded encoder interface

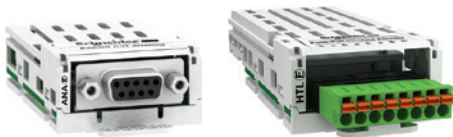

VW3A3422 analog interface encoder module VW3A3424 HTL encoder interface module



VW3A3423 resolver interface encoder module VW3A3420 digital interface encoder module 5/12 V

Presentation

Altivar Machine ATV340 variable speed drives from ATV340U07...D22N4● have an on-board encoder interface. The on-board encoder interface 1 supports RS422 for A/B/I incremental and 1 Vpp for Sin/Cos signals.

References from ATV340D30N4E...D75N4E do not have an on-board encoder interface, however optional encoder modules can be used for flux vector control operation with sensor (FVC mode) for asynchronous motors, or for vector control operation with speed feedback (FSY mode) for synchronous motors.

They improve drive performance irrespective of the motor load state:

- Zero speed torque
- Accurate speed regulation
- Torque accuracy
- Shorter response times on a torque surge
- Improved dynamic performance in transient state

For asynchronous motors, encoder interface modules improve static speed accuracy in different control modes (voltage vector control, voltage/frequency ratio).

Depending on the model, encoder interface modules can also be used for monitoring, irrespective of the control type:

- Overspeed detection
- Load slipping detection

They can also transmit a reference value provided by the encoder input to the Altivar variable speed drive. This specific feature is used to synchronize the speed of several drives. The encoder options have a thermal sensor input to monitor one standard temperature sensor.

Three modules are available depending on the encoder technology:

- Resolver encoder
- Encoder with digital output
- Encoder with analog output

The Altivar variable speed drive can only be equipped with one of the encoder interface modules. The interface encoder module is inserted in a dedicated slot (see page 35).

It is protected against encoder supply short-circuits and overloads.

References

Description	Technology type	Used with encoder (1)	Power supply	Maximum current	Maximum cable length	Maximum operating frequency	Supported thermal sensors	Reference	Weight					
									kg/lb					
Resolver interface encoder module	Resolver	–	–	50	100/328	3...12	PTC (digital/linear), PT100, PT1000, Klixon	VW3A3423	0.150/0.331					
Digital interface encoder module 5/12 V	A/B/I	XCC1●●●●●●R	5, 12, or 24	250, 100	100/328	1,000	PTC (digital/linear), PT100, PT1000, Klixon	VW3A3420	0.150/0.331					
		XCC1●●●●●●X												
		SSI								XCC2●●●●●●S●●	5, 12, or 24	250, 100	50/164 (2)	1,000 (2)
		XCC3●●●●●●S●●												
Analog interface encoder module	1 Vpp	–	5, 12, or 24	250, 100	100/328	100	PTC (digital/linear), PT100, PT1000, Klixon	VW3A3422	0.150/0.331					
										SinCos	5, 12, or 24	250, 100	100/328	100
										Hiperface®				
HTL encoder interface module	HTL	–	12, 15, or 24	200, 175, 100	500/1,640	300	–	VW3A3424	0.150/0.331					

Connection accessories (3)

Description	Composition	Length m/ft	Reference	Weight kg/lb
Cordset				
Cordset equipped with 1 x 15-way high density male SUB-D connector for digital or analog encoder modules	–	1/3.28	VW3M4701	–
Connecting cable				
Cable for creating cordsets for encoder interface modules	3 x (2 x 0.14 mm ² /AWG 26) + 2 x (2 x 0.34 mm ² /AWG 22)	25/82.02	VW3M8222R250	1.400/3.086
		50/164.04	VW3M8222R500	2.800/6.173
		100/328.08	VW3M8222R1000	5.600/12.346
		100/328	VW3M8221R1000	21.000/46.297
	5 x (2 x 0.25 mm ² /AWG 24) + 1 x (2 x 0.5 mm ² /AWG 20)			

(1) To determine the complete reference, please refer to the "Detection automation solutions - OsSense" catalog.

(2) With propagation delay compensation on EnDat® up to 100 m/328 ft and higher maximum frequencies possible, SSI 300 kHz up to 100 m/328 ft possible.

(3) See the complete list of connection accessories on our website www.schneider-electric.com.

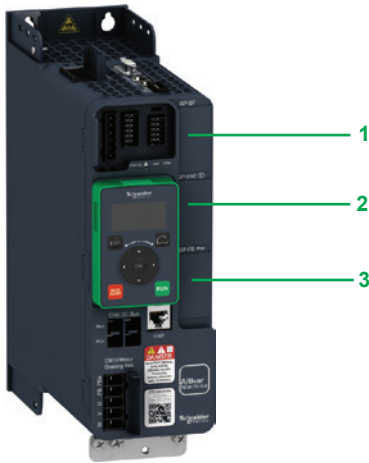

ATV340 Ethernet drives equipped with plain text display terminal



VW3A3203



VW3A3204

Additional I/O modules

Presentation

By installing additional I/O modules Altivar Machine drives can be adapted to meet the needs of applications that manage additional sensors or specific sensors.

Two additional modules are available:

- The extended I/O module, with digital and analog I/O
- The extended relay module, with relay outputs

These modules are inserted in slots 1 and 2 on Altivar Machine drives:

- 1 GP-SF slot for additional I/O or Safety function modules
- 2 GP-ENC slot for additional I/O or encoder modules
- 3 GP-FB slot for additional I/O or communication option modules

Extended I/O module

- 2 differential analog inputs configurable via software as current (0-20 mA/4-20 mA), or for PTC, PT100, or PT1000 probes, 2- or 3-wire
- 14-bit resolution
- 6 x 24 V $\overline{\text{V}}$ positive or negative digital inputs
- Sampling: 1 ms max
- 2 assignable digital outputs
- 2 removable spring terminal blocks

Extended relay module

- 3 relay outputs with NO contacts
- 1 fixed screw terminal block

Additional I/O modules

Description	I/O type				Reference	Weight kg/lb
	Digital inputs	Digital outputs	Analog inputs	Relay outputs		
Extended I/O module	6	2	2 (1)	–	VW3A3203	–
Extended relay module	–	–	–	3 (2)	VW3A3204	–

(1) Differential analog inputs configurable via software as current (0-20 mA/4-20 mA), voltage (+/- 10V), or for PTC, PT100, or PT1000 probes, 2- or 3-wire. When configured as PTC probe inputs, they must never be used to protect an ATEX motor in applications in explosive atmospheres. Please refer to the ATEX guide on our website www.schneider-electric.com.

(2) NO contacts.

Note: The extended I/O and relay modules can be placed in slot A or slot B for reference ATV340D30...D75N4E on Altivar Machine ATV340 variable speed drives. For more details, please refer to the instruction sheets, [EAV76404](#) and [EAV76405](#). Two modules of the same type cannot be inserted in Altivar Machine ATV340 variable speed drives.

Variable speed drives

Altivar Machine ATV340

Communication buses and networks



ATV340 Ethernet drive equipped with plain text display terminal



ATV340 Sercos drive equipped with plain text display terminal

Presentation

Altivar Machine ATV340 drives are designed to meet configuration requirements found in the main industrial communication installations. ATV340 variable speed drives have a Modbus serial line port **2** as standard, a single port for connecting the display, and a single port for connection to the configuration tool. ATV340●●●N4E Ethernet-type drives are equipped with multi-Ethernet protocol. Ethernet IP and Modbus TCP are available as standard with dual RJ45 ports **4**. ATV340●●●N4S drives are equipped with a Sercos protocol as standard with dual RJ45 ports **5**.

Modbus serial link

There are two ports using Modbus RTU protocol for connecting to the HMI and commissioning.

The HMI serial link port is designed for simple integration of the Magelis HMI terminal:

- Magelis HMI terminal
- Remote plain text display terminal **1**, remote graphic display terminal

The commissioning port **2** is used to configure the parameters or monitor the status of the variable speed drive, using SoMove setup software

Dual port multi-Ethernet communication

Altivar Machine ATV340 Ethernet drives integrate the EtherNet/IP and Modbus TCP communication protocols as standard.

- EtherNet/IP and Modbus TCP dual port **4**

This offers the standard services regularly used in industrial networks: connection to the Modbus TCP or EtherNet/IP network

- EtherNet IP adapter including standard CIP objects (AC/DC drive objects, CIP energy objects, etc.), compliant with ODVA specification
- The RSTP connection allows ring topology to help ensure continuity of service.
- The dual port allows daisy-chain connection to simplify cabling and network infrastructure (no need to use a switch).
- Modbus TCP message handling is based on the Modbus protocol and is used to exchange process data with other network devices (e.g., a PLC). It provides ATV340E drives with access to the Modbus protocol and to the high performance of the Ethernet network, which is the communication standard for numerous devices.
- SNMP (Simple Network Management Protocol) offers standard diagnostics services for network management tools.
- The FDR (Fast Device Replacement) service allows automatic reconfiguration of a new device installed to replace an existing device.
- Device security is reinforced by disabling some unused services as well as managing a list of authorized devices.
- Setup and adjustment tools (SoMove, EcoStruxure Machine Expert with DTM) can be connected locally or remotely.
- The embedded Web server is used to display operating data and dashboards as well as to configure and diagnose system elements from any Web browser. These numerous services offered by Altivar Machine ATV340E drives simplify integration into Schneider Electric machine automation controllers such as M241 and M251.

Altivar Machine ATV340 Sercos drives integrate the Sercos communication protocols as standard.

- Sercos dual port **5**

This offers the standard services regularly used in industrial networks: connection to Sercos network

- Sercos allows ring topology to help ensure continuity of service.
- The dual port allows daisy chain connection to simplify cabling and network infrastructure (no need to use a switch).
- The FDR (Fast Device Replacement) service allows a user reconfiguration of a new device installed to replace an existing device.
- Setup and adjustment tools (SoMove with DTM over Serial Line) can be connected.

Communication modules for industrial applications

The following communication modules are available as options (1):

- CANopen
- PROFIBUS DP V1
- DeviceNet
- EtherCAT
- ProfiNet
- POWERLINK

(1) Not compatible with Sercos drive.

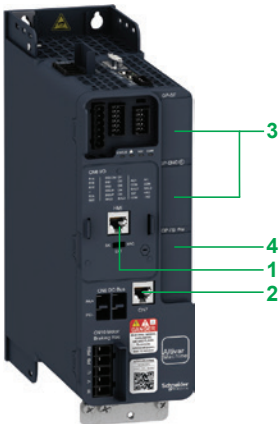

ATV340 modular drive

Description

Altivar Machine ATV340 drives have been designed to simplify connections to communication buses and networks by means of the following:

- 1 Integrated RJ45 communication port for HMI on the front
- 2 Integrated RJ45 communication port for Modbus on the front
- 3 Slots available for the additional I/O modules, encoder modules, and Safety function module (see [page 32](#))
- 4 Slots available for inserting communication modules in ATV340 modular drives, ATV340...N4

Functions

Altivar Machine ATV340 drive functions can be accessed via the communication buses and networks:

- Control
- Monitoring
- Adjustment
- Configuration

The speed reference and command may come from different sources:

- Digital input or analog I/O terminals
- Communication bus or network
- Remote/Local display terminals
- PTI interface (1)

As one of the advanced functions, ATV340 drive control sources can be managed and switched according to the application requirements.

The communication periodic I/O data assignment can be selected using the network configuration software.

The ATV340 Modular and Ethernet drives can be controlled:

- According to the CiA 402 native profile
- According to the I/O profile

The ATV340 Sercos drives are controlled by Sercos.

Communication is monitored according to criteria specific to each protocol.

Regardless of protocol type, the response of the drive to a detected communication interruption can be configured as follows:

- Freewheel stop, stop on ramp, fast stop, or braked stop
- Maintain the last command received
- Fallback position at a predefined speed
- Ignore the detected error

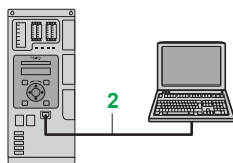

ATV340 Modular drive using Modbus to connect drive with the basic display terminal and PC

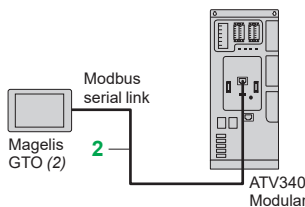

Example of connecting a modular ATV340 drive to a Magelis GTO HMI terminal via the Modbus serial link

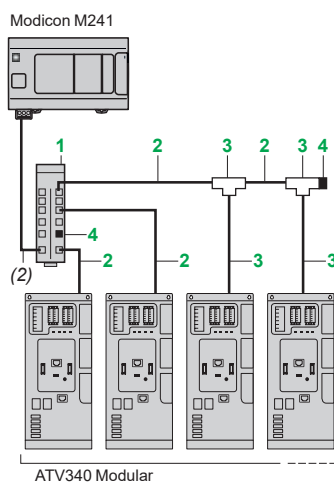

Example of Modbus diagram with connection via splitter box and RJ45 connectors

Modbus serial link

Connection accessories for remote Human Machine Interface (2)

Description	Item no.	Length m/ft	Reference	Weight kg/lb
Modbus splitter box 10 RJ45 connectors and 1 screw terminal block	1	-	LU9GC3	0.500/ 0.110
Cordsets for Modbus serial link equipped with 2 RJ45 connectors	2	0.3/0.98	VW3A8306R03	0.025/ 0.055
		1/3.28	VW3A8306R10	0.060/ 0.132
		3/9.84	VW3A8306R30	0.130/ 0.287
Modbus T-junction boxes (with integrated cable)	3	0.3/0.98	VW3A8306TF03	0.190/
		1/3.28	VW3A8306TF10	0.210/
Line terminators for RJ45 connector Set of 2 (3)	4	-	VW3A8306RC	0.020/ 0.044
		-	VW3A8306R	0.020/ 0.044

(1) PTI interface is available for ATV340U07...DD22N4 and ATV340U07...D22N4E drives.

(2) See [page 24](#) for connection of a remote display terminal or remote graphic display terminal.

(3) Requires a 24 V $\bar{\text{---}}$ power supply. Please consult the [HMI page](#) on our website.

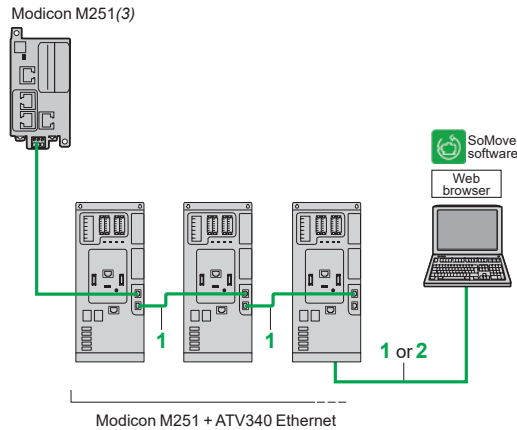

Example of connection on an EtherNet/IP network

Modbus TCP network and EtherNet/IP network

Description	Item no.	Length m/ft (2)	Reference	Weight kg/lb
ConneXium cordsets (1) (2)				
Straight shielded twisted pair cordsets	1	2/ 6.56	490NTW00002	—
equipped with 2 RJ45 connectors		5/ 16.4	490NTW00005	—
Conforming to EIA/TIA-568 category 5 and IEC 11801/EN 50173-1, class D standards		12/ 39	490NTW00012	—
Crossed shielded twisted pair cordsets	2	5/ 16.4	490NTC00005	—
equipped with 2 RJ45 connectors		15/ 49	490NTC00015	—
Conforming to EIA/TIA-568 category 5 and IEC 11801/EN 50173-1, class D standards				
Straight shielded twisted pair cordsets	1	2/ 6.56	490NTW00002U	—
equipped with 2 RJ45 connectors		5/ 16.4	490NTW00005U	—
Conforming to UL and CSA 22.1 standards		12/ 39	490NTW00012U	—
Crossed shielded twisted pair cordsets	2	5/ 16.4	490NTC00005U	—
equipped with 2 RJ45 connectors		15/ 49	490NTC00015U	—
Conforming to UL and CSA 22.1 standards				
Sercos cables				
Sercos cables for redundant Sercos ring		0.5/ 1.64	VW3E5001R005	0.045/ 0.100
equipped with 2 RJ45 connectors		1/ 3.28	VW3E5001R010	0.045/ 0.100
		1.5/ 4.92	VW3E5001R015	0.045/ 0.100
		2/ 6.56	VW3E5001R020	0.045/ 0.100
		3/ 9.84	VW3E5001R030	0.045/ 0.100
		5/ 16.4	VW3E5001R050	0.045/ 0.100
		10/ 33	VW3E5001R100	0.045/ 0.100
		15/ 49	VW3E5001R150	0.045/ 0.100
		20/ 66	VW3E5001R200	0.045/ 0.100
		25/ 82	VW3E5001R250	0.045/ 0.100
		30/ 98	VW3E5001R300	0.045/ 0.100
		40/ 131	VW3E5001R400	0.045/ 0.100
		50/ 164	VW3E5001R500	0.045/ 0.100

(1) For other ConneXium connection accessories, please refer to the "ConneXium - Connecting Ethernet devices" catalog.

(2) Also available in 40 m/131 ft and 80 m/262 ft lengths (1).

(3) Please refer to the "Modicon M251 Logic controllers" catalog ref. [DIA3ED2140108EN](#).

Variable speed drives

Altivar Machine ATV340

Communication buses and networks



VW3A3608

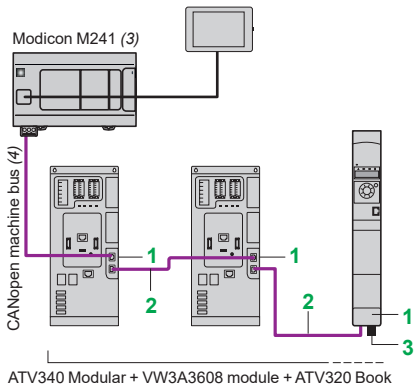

VW3A3618

CANopen machine bus

Description	Item no.	Length m/ft	Unit reference	Weight kg/lb
Connection with VW3A3608 CANopen daisy chain module (optimized solution for daisy-chain connection to the CANopen machine bus)				
CANopen daisy chain communication module Ports: 2 RJ45 connectors	1	–	VW3A3608	–
CANopen cordsets equipped with 2 RJ45 connectors	2	0.3/ 0.98	VW3CANCARR03	0.050/ 0.110
		1/ 3.28	VW3CANCARR1	0.500/ 1.102
CANopen line terminator for RJ45 connector	3	–	TCSCAR013M120	–
CANopen terminal adapter 2 RJ45 connectors for daisy-chain connection		0.3/ 0.98	TCSCCTN023F13M03	–
Connection via SUB-D connector with VWA3618 CANopen module				
CANopen communication module Port: 1 x 9-way male SUB-D connector		–	VW3A3618	–
CANopen cable Standard cable, C€ marking Low smoke zero halogen Flame retardant (IEC 60332-1)		50/ 164	TSXCANCA50	4.930/ 10.869
		100/ 328	TSXCANCA100	8.800/ 19.401
		300/ 984	TSXCANCA300	24.560/ 54.145
CANopen cable Standard cable, UL certification, C€ marking Flame retardant (IEC 60332-2)		50/ 164	TSXCANCB50	3.580/ 7.892
		100/ 328	TSXCANCB100	7.840/ 17.284
		300/ 984	TSXCANCB300	21.870/ 48.215
CANopen cable Cable for harsh environments (1) or mobile installations, C€ marking Low smoke zero halogen Flame retardant (IEC 60332-1)		50/ 164	TSXCANCD50	3.510/ 7.738
		100/ 328	TSXCANCD100	7.770/ 17.130
		300/ 984	TSXCANCD300	21.700/ 47.840
CANopen bus connector with line terminator - one 9-way female SUB-D connector		–	VW3M3802	0.175/ 0.386
CANopen connector SUB-D9 with line terminator (can be disabled). 180° cable outlet for 2 CANopen cables CAN-H, CAN-L, CAN-GND connection		–	VW3CANKCDF180T	–
CANopen IP20 straight connector SUB-D9 with line terminator (can be disabled)		–	TSXCANKCDF180T	0.049/ 0.108
IP20 CANopen right angle connector (2) SUB-D9 with line terminator (can be disabled)		–	TSXCANKCDF90T	0.046/ 0.101

(1) Standard environment:

- No particular environmental constraints
- Operating temperature between 5 and 60 °C/41 and 140 °F
- Fixed installation

Harsh environment:

- Resistance to hydrocarbons, industrial oils, detergents, solder splashes
- Relative humidity up to 100%
- Saline atmosphere
- Operating temperature between -10 and +70 °C/14 and 158 °F
- Significant temperature variations

(2) Incompatible with side-by-side mounting.

(3) Please refer to the "Modicon M241 logic controller" catalog ref. [DIA3ED2140107EN](#), "Modicon M251 logic controller" catalog ref. [DIA3ED2140108EN](#), and "Magelis SCU small HMI controllers" catalog ref. [DIA5ED2130505EN](#).

(4) Cable dependent on the type of controller or PLC; please refer to the corresponding catalog on our website www.se.com.

Variable speed drives

Altivar Machine ATV340

Communication buses and networks



VW3A3628

CANopen machine bus (continued)			
Description	Length m/ft	Unit reference	Weight kg/lb
Connection via terminals with VW3A3628 CANopen module			
CANopen communication module Port: 1 x 5-way screw terminal block	–	VW3A3628	–
CANopen line terminator for screw terminal connector	–	TCSCAR01NM120	–
Other connection accessories and cordsets			
IP20 CANopen cordsets equipped with 2 x 9-way female SUB-D connectors.	0.3/ 0.98	TSXCANCADD03	0.091/ 0.201
Standard cable, C€ marking	1/	TSXCANCADD1	0.143/ 0.315
Low smoke zero halogen	3.28		
Flame retardant (IEC 60332-1)	3/	TSXCANCADD3	0.295/ 0.650
	9.84		
	5/	TSXCANCADD5	0.440/ 0.970
	16.4		
IP20 CANopen cordsets equipped with 2 x 9-way female SUB-D connectors.	0.3/ 0.98	TSXCANCBDD03	0.086/ 0.190
Standard cable, UL certification, C€ marking	1/	TSXCANCBDD1	0.131/ 0.289
Flame retardant (IEC 60332-2)	3.28		
	3/	TSXCANCBDD3	0.268/ 0.591
	9.84		
	5/	TSXCANCBDD5	0.400/ 0.882
	16.4		
CANopen terminal adapter 2 spring terminals for daisy-chain connection	0.6/ 1.96	TCSCTN026M16M	–
IP20 CANopen junction boxes equipped with: ■ 4 x 9-way male SUB-D connectors + screw terminal block for trunk cable tap link ■ Line terminator	–	TSXCANTDM4	0.196/ 0.432
IP20 CANopen junction boxes equipped with: ■ 2 screw terminal blocks for trunk cable tap link ■ 2 RJ45 connectors for connecting drives ■ 1 RJ45 connector for connecting a PC	–	VW3CANTAP2	0.480/ 1.058

Variable speed drives

Altivar Machine ATV340

Communication buses and networks

PF095130



VW3A3607

PROFIBUS DP V1 bus

Description	Reference	Weight kg/lb
PROFIBUS DP V1 communication module Port: 1 x 9-way female SUB-D connector Conforming to PROFIBUS DP V1 Profiles supported: ■ CiA 402 drive ■ Profidrive Offers several message handling modes based on DP V1	VW3A3607	0.140/ 0.308

PF095140

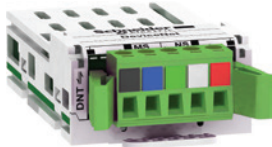

VW3A3609

DeviceNet bus

Description	Reference	Weight kg/lb
DeviceNet communication module Port: 1 removable 5-way screw connector Profiles supported: ■ CIP AC DRIVE ■ CiA 402 drive	VW3A3609	0.300/ 0.661

PF102282



VW3A3601

EtherCAT bus

Description	Reference	Weight kg/lb
EtherCAT communication module Port: 2 RJ45 connectors	VW3A3601	0.290/ 0.639

PF130913



VW3A3627

ProfiNet network

Description	Reference	Weight kg/lb
ProfiNet communication module Port: 2 RJ45 connectors	VW3A3627	0.300/ 0.660

PF095144



VW3A3619

POWERLINK network

Description	Reference	Weight kg/lb
Ethernet POWERLINK communication module Port: 2 RJ45 connectors	VW3A3619	0.300/ 0.660

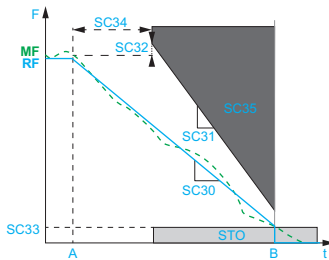

Activation of the SS1 function

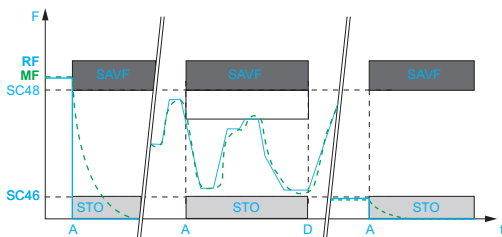

Activation of the SLS function

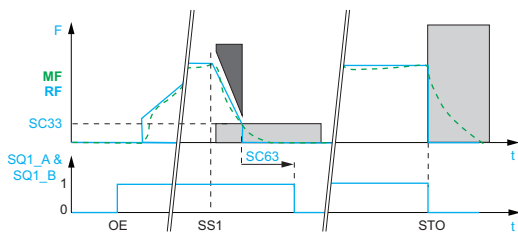

Activation of the SBC function

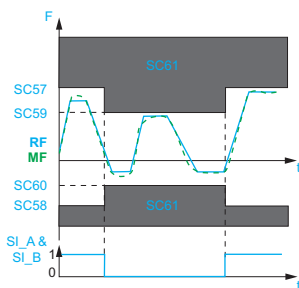

Activation of the SMS function



VW3A3802 Safety module



VW3M8820

Presentation

The Safety module allows Altivar 340 variable speed drives to access additional Safety functions.

This creates a complex functional Safety device that helps to provide installation monitoring.

The Safety module optimizes the overall cost of the installation by avoiding the need for additional external devices, while conforming to international safety standards. As a result, wiring is cheaper and quicker.

It also improves performance during maintenance by reducing machine or installation downtime and helps to ensure work is carried out in compliance with safety standards.

It includes the following Safety functions compliant with standard IEC/EN 61800-5-2.

- Safe Stop 1 (SS1)
- Safe Limited Speed (SLS)
- Safe Brake Control (SBC)

In addition, the Safety module includes two additional Safety functions.

- Safe Maximum Speed (SMS)
- Guard Door Locking (GDL)

Safety functions

Safe Stop 1 (SS1) function

The SS1 integrated Safety function causes a category 1 safe stop. This function monitors deceleration according to a dedicated deceleration ramp and safely shuts off the torque once standstill has been achieved.

Safe Limited Speed (SLS) function

The SLS integrated Safety function can be initiated by activating Safety function inputs. This function helps to prevent the motor from exceeding the specified speed limit. If the motor speed exceeds the specified speed limit value, safety function STO is triggered.

Safe Brake Control (SBC) function

The SBC integrated Safety function provides a safe output signal to command an external relay in order to control external brakes.

Safe Maximum Speed (SMS) function

This function helps to prevent the speed of the motor from exceeding the predefined speed limit.

- Two different speed limits can be defined and can be selected by logic inputs.
- If the motor speed exceeds the predefined speed limit value, Safety function STO is triggered.

Once the SMS function is configured, it is continuously active.

Guard Door Locking (GDL) function

The GDL function allows the guard door lock to be released when the motor power is turned off.

References

Description	Power supply V	Cable length m/ft	Unit reference	Weight kg/lb
Safety module for ATV340	24 V $\overline{\text{DC}}$	–	VW3A3802	–
Cordset Preassembled with 2 x 24-way female connectors (Safety module end) and a free end	–	3/ 9.84	VW3M8801R30	0.020/ 0.040
Cordsets Preassembled with 2 x 24-way female connectors	–	1.5/ 4.92	VW3M8802R15	0.020/ 0.040
		3/ 9.84	VW3M8802R30	0.150/ 0.330
Safety module distribution unit Connection terminal adapter for Safety module, for easy wiring of several Safety modules in the control cabinet (equipped with 5 connectors)	–	–	VW3M8810	–
Removable connector To connect an additional Safety module distribution unit	–	–	VW3M8820	–

Sold in lots of 4

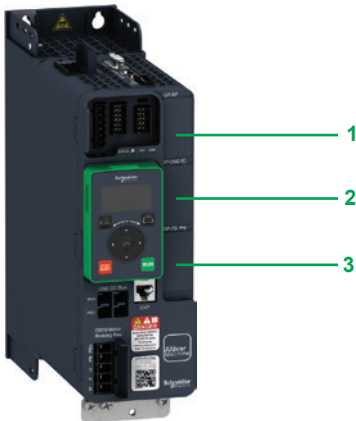

Safety module in the GP-SF slot



Safety module in the GP-SF slot and connector

Safety module

Presentation

The Safety module allows Altivar 340 variable speed drives to access additional Safety functions. This creates a complex Safety device that helps to provide installation monitoring.

- 1 GP-SF slot for additional I/O or Safety function modules
- 2 GP-ENC slot for additional I/O or encoder modules
- 3 GP-FB slot for additional I/O or communication option modules

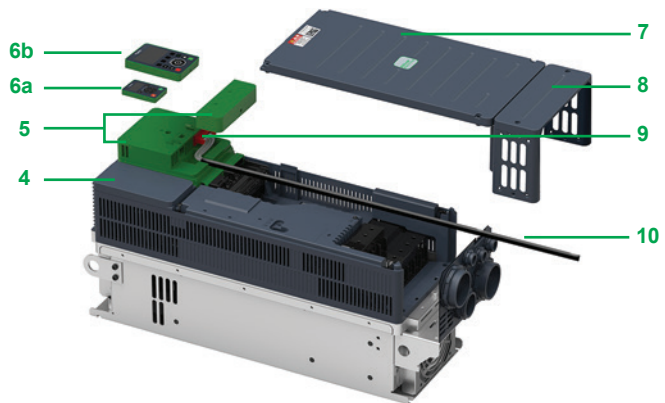

Another form of ATV340 with VW3A1111 (advanced keypad), and VW3A3800 (Hoist option), and connector under front cover and conduit box

- 4 ATV340D37N4E
- 5 Additional module support VW3A3800
- 6a Plain text display terminal VW3A1113
- 6b Graphic display terminal VW3A1111
- 7 Front cover
- 8 Conduit box
- 9 Safety function module VW3A3802
- 10 Cordset

Additional module support

Presentation

The additional module support allows ATV340 drives above 22 kW/30 HP to have an additional third slot for option modules such as additional I/O, fieldbus, encoder interface, and Safety module.

Altivar 340 drives above 22 kW must be equipped with an additional module support (VW3A3800) in order to insert the Safety module (VW3A3802).



VW3A3800

References

Description	Reference
Safety function module	Safety function module, extended Safety level VW3A3802
Additional module support	Additional module to be used in the range above 22 kW ATV340D30N4E...ATV340D75N4E VW3A3800

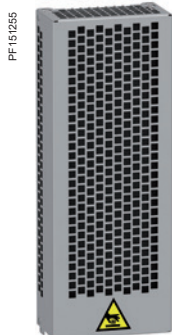

VW3A7741

Presentation

Braking resistors allow Altivar Machine ATV340 drives to operate while braking to a standstill, by dissipating the braking energy. They enable maximum transient braking torque.

Braking resistors are designed to be located outside the enclosure, but should not inhibit natural cooling. Air inlets and outlets must not be obstructed in any way. The air should be free of dust, corrosive gas, and condensation.

The internal circuits of Altivar Machine drives have a built-in dynamic braking transistor. Depending on the drive rating, the enclosed external braking resistor with IP20 and IP23 protection is designed to comply with the EMC standard and monitored by a temperature-controlled switch or thermal overload relay.

Applications

Braking resistors are designed for a defined cycle (see the 3 cycle types defined below). Depending on your own applications and cycles, you can use these resistors or define a new value.

- Braking resistors for light braking cycles for machines with cycles and inertia. The braking power is limited to 1.5 Tn for 0.8 s every 40 s.
- Braking resistors for medium braking cycles for machines with high inertia and conveyors. The braking power is limited to 1.35 Tn for 4 s every 40 s.
- Braking resistors for severe braking cycles for machines with very high inertia and vertical movements (hoisting). The braking power is limited to 1.65 Tn for 6 s and Tn for 54 s every 120 s.

Below are the list of the associated braking resistors according to the required braking cycle (1).

References for a light braking cycle

For drives	Degree of protection of the resistor	Ohmic value at 20 °C/ 68 °F	Average power available at 50 °C/ 122 °F (2)	Quantity required per drive	Reference	Weight
		Ω	kW			kg/lb
Supply voltage: 380...480 V 50/60 Hz						
ATV340U07...U30N4●	IP20	100	0.1	1	VW3A7730	1.500/ 3.307
ATV340U40...U55N4●	IP20	60	0.16	1	VW3A7731	2.000/ 4.409
ATV340U75...D11N4●	IP20	28	0.3	1	VW3A7732	3.000/ 6.614
ATV340D15...D22N4●	IP20	16	1.1	1	VW3A7733	4.000/ 8.818
ATV340D30...D37N4E	IP20	10	1.1	1	VW3A7734	5.500/ 12.125
ATV340D45N4E	IP20	8	1.1	1	VW3A7735	5.500/ 12.125
ATV340D55...D75N4E	IP23	5	1.9	1	VW3A7736	18.000/ 39.683

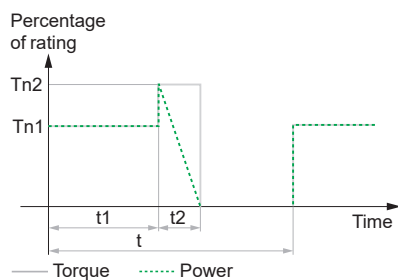

Light cycle

t = 40 s	t: period
t1 = 0 s	Tn1: braking torque
t2 = 0.8 s	Tn2: braking torque
Tn1 = 0	Tn: nominal torque
Tn2 = 1.5 x Tn	

Light braking cycle

(1) The minimum braking resistor ohmic value of the drive can be found in the installation manual. For more information, please visit our website: www.schneider-electric.com.

(2) Load factor for resistors: The value of the average power that can be dissipated at 50 °C/122 °F from the resistor into the casing is determined for a load factor during braking that corresponds to the majority of normal applications:

- Normal duty: 0.8 s braking with a 1.2 Tn braking torque for a 40 s cycle
- Heavy duty: 0.8 s braking with a 1.5 Tn braking torque for a 40 s cycle

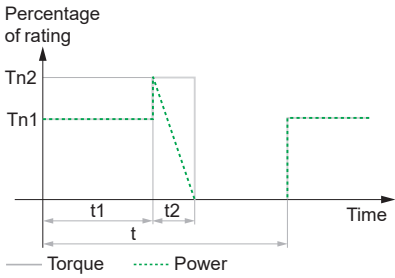

Medium cycle	
$t = 40\text{ s}$	t : period
$t1 = 0\text{ s}$	$Tn1$: braking torque
$t2 = 4\text{ s}$	$Tn2$: braking torque
$Tn1 = 0$	Tn : nominal torque
$Tn2 = 1.35 \times Tn$	

Medium braking cycle

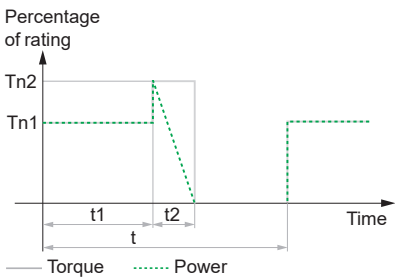

Severe cycle	
$t = 120\text{ s}$	t : period
$t1 = 54\text{ s}$	$Tn1$: braking torque
$t2 = 6\text{ s}$	$Tn2$: braking torque
$Tn1 = Tn$	Tn : nominal torque
$Tn2 = 1.65 \times Tn$	

Severe braking cycle

References for a medium braking cycle

For drives	Degree of protection of the resistor	Ohmic value at 20 °C/ 68 °F	Average power available at 50 °C/ 122 °F (1)	Quantity required per drive	Reference	Weight
		Ω	kW			kg/lb
Supply voltage: 380...480 V 50/60 Hz						
ATV340U07N4●	IP20	100	0.1	1	VW3A7730	1.500/ 3.307
ATV340U15...U30N4●	IP20	100	0.26	1	VW3A7740	2.500/ 5.512
ATV340U40...U55N4●	IP20	60	0.5	1	VW3A7741	4.500/ 9.921
ATV340U75...D11N4●	IP20	28	1.1	1	VW3A7742	4.000/ 8.818
ATV340D15...D22N4●	IP20	16	2.2	1	VW3A7743	7.000/ 15.432
ATV340D30...D37N4E	IP20	10	3.4	1	VW3A7744	11.500/ 25.353
ATV340D45N4E	IP23	8	3.8	1	VW3A7745	23.000/ 50.706
ATV340D55...D75N4E	IP23	5	6.9	1	VW3A7746	27.000/ 59.525

References for a severe braking cycle (hoisting applications)

For drives	Degree of protection of the resistor	Ohmic value at 20 °C/ 68 °F	Average power available at 50 °C/ 122 °F (2)	Quantity required per drive	Reference	Weight
		Ω	kW			kg/lb
Supply voltage: 380...480 V 50/60 Hz						
ATV340U07...U30N4●	IP20	100	1.7	1	VW3A7750	5.500/ 12.125
ATV340U40...U55N4●	IP20	60	3.4	1	VW3A7751	10.000/ 22.046
ATV340U75...D11N4●	IP23	28	5.1	1	VW3A7752	25.000/ 55.116
ATV340D15...D22N4●	IP23	16	14	1	VW3A7753	47.000/ 103.617
ATV340D30...D37N4E	IP23	10	19	1	VW3A7754	67.000/ 147.710
ATV340D75N4E	IP23	10	19	2		
ATV340D45N4E	IP23	8	25	1	VW3A7755	86.000/ 189.597
ATV340D55N4E	IP23	5	32	1	VW3A7756	120.000/ 264.554

(1) Load factor for resistors: The value of the average power that can be dissipated at 50 °C/122 °F from the resistor into the casing is determined for a load factor during braking that corresponds to the majority of normal applications:
 - Normal duty: 4 s braking with a 1.35 Tn braking torque for a 40 s cycle
 - Heavy duty: 4 s braking with a 1.65 Tn braking torque for a 40 s cycle
 (2) Load factor for resistors: The value of the average power that can be dissipated at 50 °C/122 °C from the resistor into the casing is determined for a load factor during braking that corresponds to the majority of normal applications:
 - Heavy duty: 54 s braking with a 1 Tn braking torque and 6 s braking with a 1.65 Tn braking torque for a 120 s cycle

Variable speed drives

Altivar Machine ATV340

Integrated EMC filters and additional EMC input filters

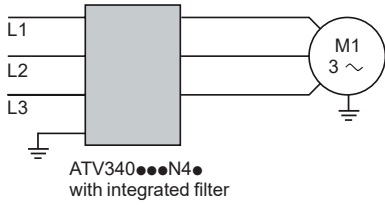

Altivar Machine drive ATV340 with integrated EMC filter

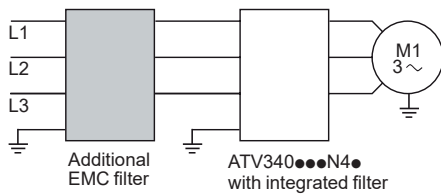

Altivar Machine drive ATV340 with additional EMC filter

Integrated EMC filters

Altivar Machine ATV340 drives have integrated radio interference input filters to comply with the EMC (electromagnetic compatibility) standard for variable speed electrical power drive products IEC 61800-3 category C2 or C3 and the European EMC Directive.

The integrated EMC filters comply with standard IEC 61800-3 for a maximum motor cable length listed below:

	Maximum length of shielded cable acc. to	
	IEC/EN 61800-3 category C2	IEC/EN 61800-3 category C3
For drives	m/ft	m/ft
Three-phase supply voltage: 380...480 V IP20		
ATV340U07...D22N4●	–	20/66
ATV340D30...D37N4E	50/164	100/328
ATV340D45...D75N4E	–	100/328

Additional EMC input filters

The additional EMC input filters enable the drives to meet more stringent requirements; they are designed to reduce conducted emissions on the AC supply below the limits of standard IEC 61800-3 category C2 or C3 (see [page 47](#)).

Mounting on ATV340...N4●

Depending on the model, additional EMC filters can be mounted beside or underneath the drive.

Mounting the filter on the side of the drive: for ATV340U07...U75N4● drives

Mounting the filter underneath the drive: for ATV340D11...D22N4, ATV340D11...D75N4E, and ATV340D11...D22N4S drives

Use according to the type of AC supply

Additional EMC filters can only be used on TN (neutral connection) and TT (grounded neutral) type systems.

Standard IEC 61800-3, appendix D2.1, states that on IT systems (isolated or impedance grounded neutral), filters can cause permanent insulation monitors to operate in a random manner.

The effectiveness of additional filters on this type of system depends on the type of impedance between neutral and ground, and therefore cannot be predicted.

If a machine has to be installed on an IT system, one solution is to insert an isolation transformer and connect the machine locally on a TN or TT system.

Note:

ATV340U07...D22N4, ATV340U07...D37N4E, and ATV340U07...D22N4S drives are compatible for use with maximum 100 m/328 ft shielded motor cable length with 4 kHz switching frequency.

ATV340D37...D75N4E drives are compatible for use with maximum 100 m/328 ft shielded motor cable length with 2.5 kHz switching frequency.

Variable speed drives

Altivar Machine ATV340

Additional EMC input filters



VW3A4422



VW3A4706

References

For drives	Additional EMC input filter					
Reference	Maximum length of shielded cable (1) (2)	In (3)	Losses (4)	Filter mounted	Reference	Weight
	IEC 61800-3 (5)					
	Category C2	Category C3	A	W		kg/lb
	m/ft	m/ft				
Three-phase supply voltage: 380...480 V 50/60 Hz						
ATV340U07...U15N4●	50/ 164	100/ 328	15	9.9	On the side VW3A4422	0.600/ 1.323
ATV340U22...U75N4●	50/ 164	100/ 328	25	15.8	On the side VW3A4423	0.775/ 1.709
ATV340D11...D15N4●	50/ 164	100/ 328	50	8	On the side VW3A4711	5.200/ 11.464
ATV340D18...D22N4●	50/ 164	100/ 328	70	10	On the side VW3A4712	6.100/ 13.448
ATV340D30N4E	150/ 492	300/ 984	100	12.4	On the side VW3A4706	6.500/ 14.330
ATV340D37N4E	150/ 492	300/ 984	160	25	On the side VW3A4707	8.500/ 18.739
ATV340D45N4E	150/ 492	300/ 984	200	32.5	On the side VW3A4708	9.500/ 20.944

(1) The filter selection tables give the maximum lengths for shielded cables connecting motors to drives. These maximum lengths are given as examples only, as they vary depending on the stray capacitance of the motors and the cables used. If motors are connected in parallel, it is the total length of all cables that should be taken into account.

(2) These values are given for a nominal switching frequency of 4 kHz.

(3) In: nominal filter current.

(4) Via heat dissipation, at the nominal filter current (In).

(5) Standard IEC 61800-3: EMC immunity and conducted and radiated EMC emissions:

- Category C2: public power supply (residential) and industrial power supply
- Category C3: industrial power supply

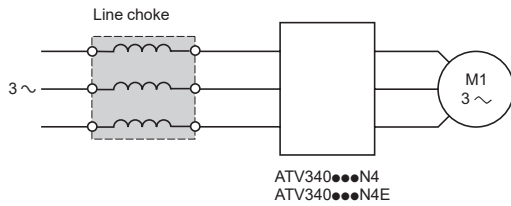

Presentation

Line chokes, also known as line reactors, provide improved immunity against overvoltages on the AC supply and can reduce harmonic distortion of the current produced by the drive.

The recommended chokes limit the input current. They have been developed in line with standard IEC 61800-5-1 (VDE 0160 level 1 high-energy overvoltages on the AC supply).

The inductance values are defined for a voltage drop between 3% and 5% of the nominal AC supply voltage. Values higher than this will cause loss of torque.

The use of line chokes is recommended in particular under the following circumstances:

- AC line supply with significant disturbance from other equipment (interference, overvoltages)
- AC line supply with voltage imbalance between phases > 1.8% of nominal voltage
- Drive supplied by an AC line supply with very low impedance (in the vicinity of a power transformer 10 times more powerful than the drive rating)
- Installation of a large number of frequency inverters on the same AC supply
- Reduction of overloads on the $\cos \varphi$ correction capacitors, if the installation includes a power factor correction unit

Line chokes are mandatory for variable speed drives **ATV340U07...D22N4**, operating in normal duty mode, and have to be ordered separately (see [page 49](#)). External line chokes are not required for variable speed drives **ATV340D30...D75N4E**, in which integrated DC chokes serve for the same purpose.



VW3A4553
VW3A4554
VW3A4555



VW3A4556

References

Drive		Choke					Inductance	Reference	Weight
Reference (3)	Operation mode	Motor power	Input current without choke		Input current with choke				
			U min. (1)	U max. (1)	U min. (1)	U max. (1)			
		kW	A	A	A	A	mH	kg/lb	
Three-phase supply voltage: 380...480 V 50/60 Hz									
ATV340U07N4●	Heavy duty	0.75	3.4	2.6	1.9	1.6	10	VW3A4551	1.500/ 3.307
	Normal duty (2)	1.1	–	–	2.6	2.1	10	VW3A4551	1.500/ 3.307
ATV340U15N4●	Heavy duty	1.5	6.0	4.9	3.5	2.8	10	VW3A4551	1.500/ 3.307
	Normal duty (2)	2.2	–	–	5.1	4.1	4	VW3A4552	3.000/ 6.613
ATV340U22N4●	Heavy duty	2.2	8.4	6.6	5.1	4.1	4	VW3A4552	3.000/ 6.613
	Normal duty (2)	3	–	–	6.6	5.3	4	VW3A4552	3.000/ 6.613
ATV340U30N4●	Heavy duty	3	10.7	8.5	6.6	5.3	4	VW3A4552	3.000/ 6.613
	Normal duty (2)	4	–	–	8.6	6.8	4	VW3A4552	3.000/ 6.613
ATV340U40N4●	Heavy duty	4	13.4	10.6	8.5	6.8	4	VW3A4552	3.000/ 6.613
	Normal duty (2)	5.5	–	–	11.4	9.0	2	VW3A4553	3.500/ 7.716
ATV340U55N4●	Heavy duty	5.5	20.0	16.0	11.6	9.4	2	VW3A4553	3.500/ 7.716
	Normal duty (2)	7.5	–	–	15.3	12.2	2	VW3A4553	3.500/ 7.716
ATV340U75N4●	Heavy duty	7.5	25.6	20.4	14.6	12.1	2	VW3A4553	3.500/ 7.716
	Normal duty (2)	11	–	–	22.0	17.7	1	VW3A4554	6.000/ 13.228
ATV340D11N4●	Heavy duty	11	34.7	27.7	21.9	17.7	1	VW3A4554	6.000/ 13.228
	Normal duty (2)	15	–	–	28.8	23.0	1	VW3A4554	6.000/ 13.228
ATV340D15N4●	Heavy duty	15	44.9	35.7	28.7	23.0	1	VW3A4554	6.000/ 13.228
	Normal duty (2)	18.5	–	–	37.4	30.2	0.5	VW3A4555	11.000/ 24.251
ATV340D18N4●	Heavy duty	18.5	54.7	43.4	37.2	30.1	0.5	VW3A4555	11.000/ 24.251
	Normal duty (2)	22	–	–	43.4	35.0	0.5	VW3A4555	11.000/ 24.251
ATV340D22N4●	Heavy duty	22	63.5	50.6	43.3	34.9	0.5	VW3A4555	11.000/ 24.251
	Normal duty (2)	30	–	–	60.1	48.6	0.3	VW3A4556	16.000/ 35.270

(1) Nominal supply voltage, $U_{min} = 380 V \sim$, $U_{max} = 480 V \sim$.

(2) A line choke is essential for the drive to operate in normal duty mode, so line current without choke is not applicable.

(3) For drives above 30 kW, ATV340D30N4E...D75N4E, a DC choke is integrated, so an extra line choke is not required.

Variable speed drives

Altivar Machine ATV340

Output filters

Option: dv/dt filters

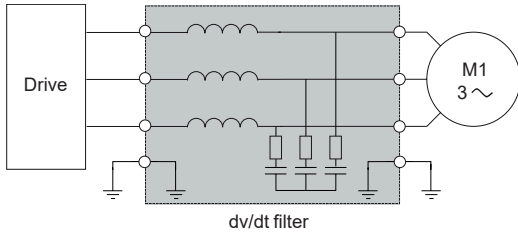

Altivar machine drive with dv/dt filter

Presentation

Altivar 340 drives with a supply voltage of 380...480 V operate with the following maximum motor cable lengths: 100 m/328 ft for unshielded/shielded cables. Altivar 340 drives rated > 4 kW, with a supply voltage of 380...480 V operate with the following maximum motor cable lengths: 150 m/492 ft for shielded cables, 300 m/984 ft for unshielded cables.

To limit the impact of dv/dt and overvoltages in the motor, it is recommended that an output filter is added for cables longer than 50 m/164 ft if the motor insulation type does not conform to IEC 60034-25.

For further information, please consult the White Paper entitled "[An Improved Approach for Connecting VSD and Electric Motors](#)".

Output filters are used to limit dv/dt at the motor terminals to 500 V/μs maximum for supply voltages up to 480 V.

Output filters are designed to limit overvoltages at the motor terminals to less than:

- 800 V with a shielded cable 0 to 50 m (0 to 164 ft) long, with a 400 V supply voltage
- 1,000 V with a shielded cable 50 to 150 m (164 to 492 ft) long, with a 400 V supply voltage
- 1,500 V with a shielded cable 150 to 300 m (492 to 984 ft) long, with a 400 V supply voltage (up to 500 m (1,640 ft) with an unshielded cable)

The performance of dv/dt filters will be affected if the maximum cable lengths are exceeded. For an application with several motors connected in parallel, the cable length must include all cabling. If a cable longer than that specified is used, the dv/dt filters may overheat.

The switching frequency must be under 8 kHz.

dv/dt output filters

For drives	Maximum length of motor cable (1)		Degree of protection (3)	In	Reference	Weight
	Maximum switching frequency (2)	Unshielded				
	kHz	m/ft	m/ft	IP	A	kg/lb
Three-phase supply voltage: 380...480 V						
ATV340U07...U15N4●	4	300/984	300/984	20	6	VW3A5301 11.000/24.251
ATV340U22...U40N4●	4	300/984	300/984	20	15	VW3A5302 12.000/26.455
ATV340U55...U75N4●	4	500/1640	300/984	20	25	VW3A5303 12.000/26.455
ATV340D11...D18N4●	4	500/1640	300/984	20	50	VW3A5304 18.000/39.683
ATV340D22N4●	4	500/1640	300/984	20	95	VW3A5305 19.000/41.888
ATV340D30...D37N4E	4	500/1640	300/984	00	180	VW3A5306 22.000/48.502

IP21 protection kit for IP20 filters

Description	For dv/dt filters	Reference	Weight kg/lb
Mechanical kit including cover and cable clamps	VW3A5401	VW3A53901	1.000/2.205
	VW3A5402	VW3A53902	1.300/2.866
	VW3A5403	VW3A53903	1.700/3.748
	VW3A5404	VW3A53904	2.700/5.952
	VW3A5405	VW3A53904	2.700/5.952

(1) Values given depend on the nominal switching frequency of the drive. This frequency depends on the drive rating. These cable lengths are given as examples only as they can vary depending on the application. They correspond to motors conforming to IEC 60034-25 and NEMA MG1/31.2006.

(2) The filters are designed to operate in a switching frequency range of between 2 and 8 kHz.

(3) Nominal filter current.

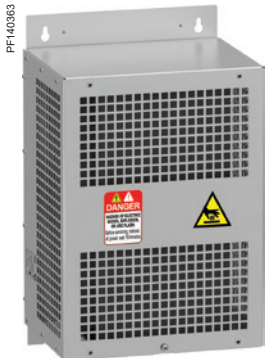

VW3A5301

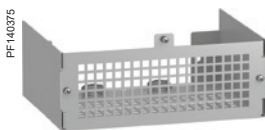

VW3A53902



VW3A53903

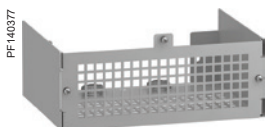

VW3A53904

Variable speed drives

Altivar Machine ATV340

Output filters

Option: dv/dt filters, common mode filters

dv/dt output filters (continued)

Upgrade from ATV71 to ATV 340: combination table

Old drive: ATV71	Old accessory: motor choke (1)	New drive: ATV340	New accessory: dv/dt filter
ATV71H075N4...HU15N4 ATV71W075N4...WU15N4 ATV71P075N4Z...PU15N4Z	VW3A5101... VW3A5103	ATV340U07...U15N4 ATV340U07...U15N4E	VW3A5301
ATV71HU22N4...HU40N4 ATV71WU22N4...WU40N4 ATV71PU22N4Z...PU40N4Z	VW3A5101... VW3A5103	ATV340U22...U40N4 ATV340U22...U40N4E	VW3A5302
ATV71HU55N4...HU75N4 ATV71WU55N4...WU75N4	VW3A5102... VW3A5104	ATV340U55...U75N4 ATV340U55...U75N4E	VW3A5303
ATV71HD11N4...HD18N4 ATV71WD11N4...WD18N4	VW3A5102... VW3A5104	ATV340D11...D18N4 ATV340D11...D18N4E	VW3A5304
ATV71HD22N4...HD37N4 ATV71WD22N4...WD37N4	VW3A5103... VW3A5104	ATV340D22N4 ATV340D22...D37N4E	VW3A5305
ATV71HD45N4...HD75N4 ATV71WD45N4...WD75N4	VW3A5104	ATV340D45...D75N4E	VW3A5306

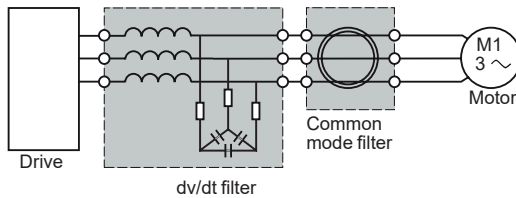

ATV340 drive with common mode filter

Presentation

dv/dt filters reduce the overvoltage across windings and high frequency currents in differential mode. But they have no effect on the common mode current between phases and the cable shielding, and between the windings and the stator/rotor of the motor.

Common mode filters bring several benefits:

- Reduction of RFI (radio frequency interference) of the motor cable and improvement of the effectiveness of the EMC filter for conducted emissions
- Reduction of the high frequency currents circulating in the bearings of the motor and prevention of their damage

It is possible to use the common mode filter or the dv/dt filter at the output terminals of the drive.

Note: The selection of a common mode configuration depends on the type and length of motor cable. An abnormal increase in temperature indicates a possible saturation. Additional filters should be used to avoid it.

Common mode filters

For drives	Maximum length of unshielded cable		
	100 m/492 ft	300 m/984 ft (2)	500 m/1,640 ft (2)
ATV340U07...U40N4●	VW3A5502	2 x VW3A5501	–
ATV340U55...U75N4●	VW3A5501	VW3A5502	VW3A5501 + VW3A5502
ATV340D11...D22N4●	VW3A5503	VW3A5504	2 x VW3A5503
ATV340D30...D75N4E	VW3A5503	VW3A5504	VW3A5503 + VW3A5504

For drives	Maximum length of shielded cable	
	100 m/492 ft	300 m/984 ft (2)
ATV340U07...U40N4●	VW3A5502	2 x VW3A5501
ATV340U55...U75N4●	VW3A5502	2 x VW3A5501
ATV340D11...D22N4●	VW3A5503	2 x VW3A5503
ATV340D30...D75N4E	VW3A5504	VW3A5503 + VW3A5504

(1) Refer to the [ATV71 catalog](#) for corresponding shielded/unshielded motor cable length and switching frequency.
(2) With dv/dt filter

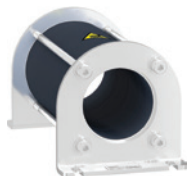

VW3A5501

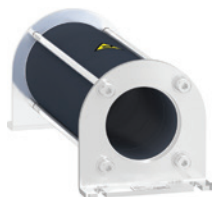

VW3A5502

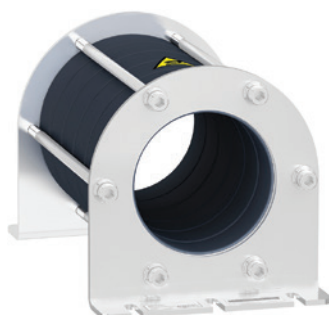

VW3A5504

Variable speed drives

Altivar Machine ATV340

Option: ATV Regenerative units

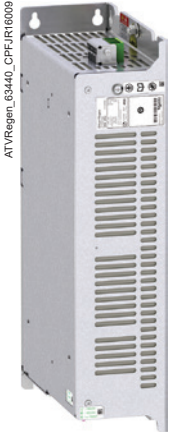

ATVRD15N4



ATVRU75N4

Presentation

The main function of the ATV Regen product is to provide an option to regenerate energy back to the AC supply for heavy braking applications such as material working, material handling, and hoisting with easy configuration.

This option should be associated with Altivar drives in the 400 V series such as Altivar 340. The braking unit harmonic performance is the same as that of standard drives.

Features:

- Chemical class 3C3 conforming to IEC/EN 60721
- Mechanical class 3S2 conforming to IEC/EN 60721
- -10..50 °C/14...122 °F without derating, up to 60 °C/140 °F with derating
- Mechanical class 3S2 conforming to IEC/EN 60721
- Built in EMC filter comply with standard IEC 61800-3

Wiring concept

Generic wiring

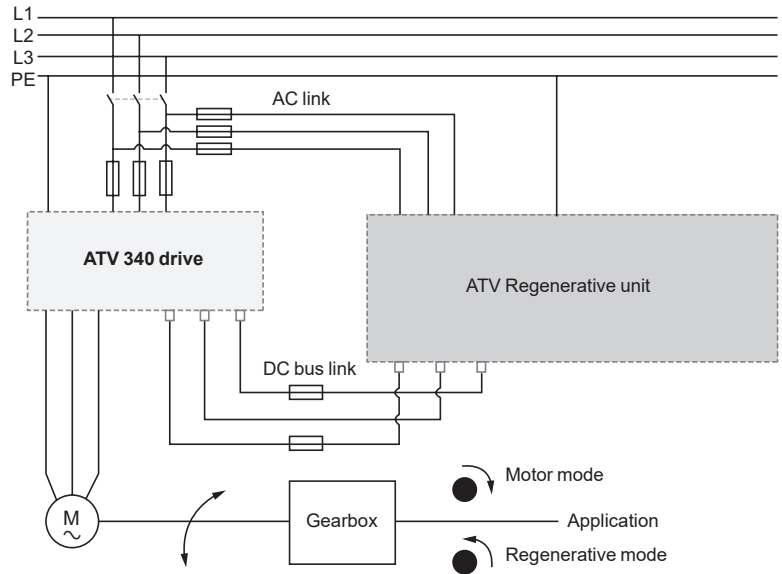

One drive for several Regenerative units

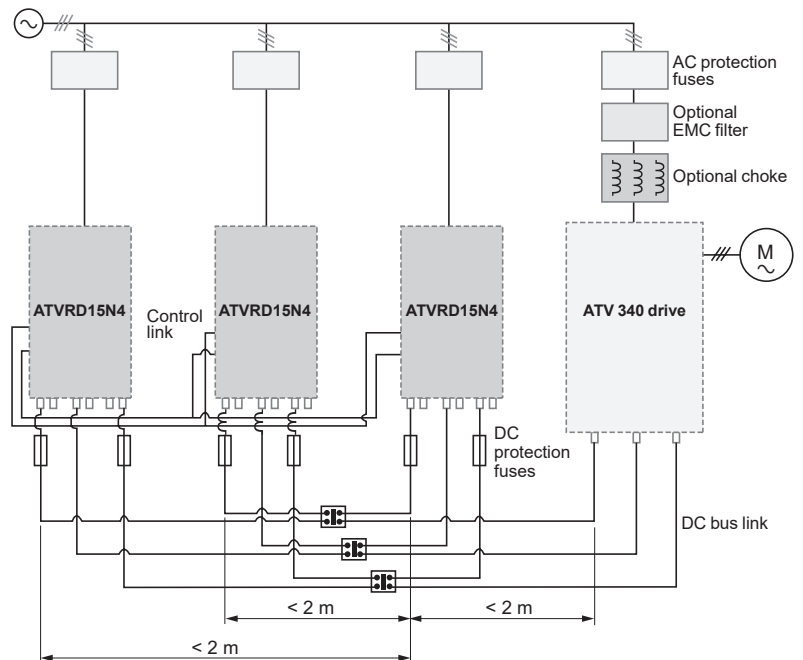



[Click to download
Altivar Regenerative Unit: Sizing Tool](#)

Wiring concept (continued)

Several drives with one Regenerative unit

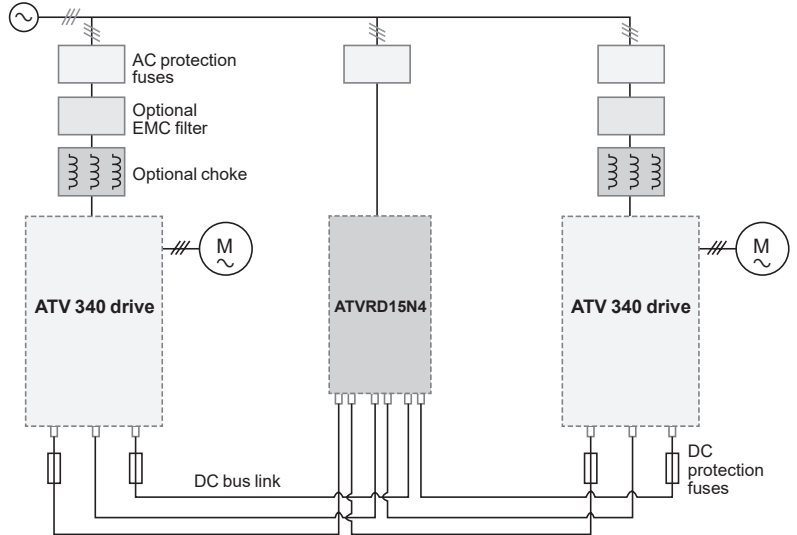

References

For drives (1)	IP	Regenerative unit reference	Weight kg/ lb
Supply voltage: 380...480 V 50/60 Hz			
ATV340U07...D22N4● ATV340D30...D37N4E	20	ATVRU75N4	6.000/ 13.228
ATV340D11...D22N4● ATV340D30...D75N4E	20	ATVRD15N4	11.500/ 25.353

(1) For sizing, refer to the [Altivar Regenerative Unit User Manual](#).

Applications

Circuit breaker/contactor/drive combinations help to ensure continuity of service in the installation.

The type of circuit breaker/contactor coordination selected can reduce maintenance costs in the event of a short-circuit on the drive input by minimizing the time required to make the necessary repairs and the cost of replacement equipment. The suggested combinations provide coordination according to the drive rating.

The drive controls the motor, provides a monitoring function against short-circuits between the drive and the motor, and helps protect the motor cable against overloads. Overload monitoring is provided by the drive's motor thermal monitoring function if this has been enabled. Otherwise, an external monitoring device such as a probe or thermal overload relay should be provided.

The circuit breaker helps protect the drive's power cables against short-circuits.

IEC standard motor starters

Motor	Drive	Circuit breaker		Line contactor
Power (1)	Reference	Reference (2)	Rating	Reference (3) (4)
kW	HP		A	A
Three-phase supply voltage: 380...415 V 50/60 Hz				
0.75	1	ATV340U07N4●	GV2L08	LC1D09●●
1.5	2	ATV340U15N4●	GV2L10	LC1D09●●
2.2	3	ATV340U22N4●	GV2L14	LC1D09●●
3	4	ATV340U30N4●	GV2L16	LC1D18●●
4	5	ATV340U40N4●		
5.5	7.5	ATV340U55N4●	GV2L22	LC1D25●●
7.5	10	ATV340U75N4●	GV3L32	LC1D40A●●
11	15	ATV340D11N4●	GV3L40	LC1D40A●●
15	20	ATV340D15N4●	GV3L50	LC1D50A●●
18.5	25	ATV340D18N4●	GV3L65	LC1D65A●●
22	30	ATV340D22N4●		
30	40	ATV340D30N4E	GV4L/LE80●	LC1D65A●●
37	50	ATV340D37N4E		LC1D80●●
45	60	ATV340D45N4E	GV4L/LE115●	LC1D115●●
55	75	ATV340D55N4E		
75	100	ATV340D75N4E	NSX250●MA220	LC1F185●●

(1) Standard power ratings for 400 V 50/60 Hz 4-pole motors.
The values expressed in HP conform to the NEC (National Electrical Code).

(2) For references to be completed, replace the dot with the letter corresponding to the breaking performance of the circuit breaker (B, F, N, H, S, or L).

Breaking capacity of circuit breakers according to standard IEC 60947-2:

Circuit breaker	Icu (kA) for 380...415 V	Icu (kA) for 380...415 V					
		B	F	N	H	S	L
GV2L08...L14	100	-	-	-	-	-	-
GV2L16...L22	50	-	-	-	-	-	-
GV3L32...L65	50	-	-	-	-	-	-
GV4L/LE80...115●	-	25	-	50	-	100	-
NSX250●MA220	-	-	36	50	70	100	150

(3) Composition of contactors:

LC1D09...D115: 3 poles + 1 NO auxiliary contact + 1 NC auxiliary contact

LC1F185: 3 poles

To add auxiliary contacts or other accessories, please refer to the "TeSys - Motor control and protection components" catalog.

(4) Replace ●● with the control circuit voltage code indicated in the table below:

	Volts ~	24	48	110	220	230	240
		LC1D09...D115	50 Hz	B5	E5	F5	M5
	60 Hz	B6	E6	F6	M6	-	U6
	50/60 Hz	B7	E7	F7	M7	P7	U7
LC1F185	50 Hz (LX1 coil)	B5	E5	F5	M5	P5	U5
	60 Hz (LX1 coil)	-	E6	F6	M6	-	U6
	40...400 Hz (LX9 coil)	-	E7	F7	M7	P7	U7

For other voltages available between 24 V ~ and 660 V ~, or a DC control circuit, please contact our [Customer Care Center](#).



GV3L65

+



LC1D65A●●

+



ATV340D22N4S



GV4L80●●

+



LC1D80●●

+



ATV340D45N4E

IEC standard motor starters						
Motor	Drive	Circuit breaker			Line contactor	
Power (1)	Reference	Reference (2)	Rating	I _{rm}	Reference (3) (4)	
kW	HP		A	A		
Three-phase supply voltage: 440 V 50/60 Hz						
0.75	1	ATV340U07N4●●	GV2L08	4	51	LC1D09●●
1.5	2	ATV340U15N4●●	GV2L10	6.3	78	LC1D09●●
2.2	3	ATV340U22N4●●	GV2L14	10	138	LC1D09●●
3	4	ATV340U30N4●●				LC1D18●●
4	5	ATV340U40N4●●	GV2L16	14	170	LC1D18●●
5.5	7.5	ATV340U55N4●●	GV2L20	18	223	LC1D25●●
7.5	10	ATV340U75N4●●	GV3L25	25	350	LC1D32●●
11	15	ATV340D11N4●●	GV3L32	32	448	LC1D40A●●
15	20	ATV340D15N4●●	GV3L50	50	700	LC1D50A●●
18.5	25	ATV340D18N4●●				
22	30	ATV340D22N4●●				
30	40	ATV340D30N4E	GV3L65	65	910	LC1D65A●●
37	50	ATV340D37N4E	GV4L/LE80●●	80	1040	LC1D65A●●
45	60	ATV340D45N4E				LC1D80●●
55	75	ATV340D55N4E	GV4L/LE115●●	115	1495	LC1D115●●
75	100	ATV340D75N4E	NSX160●●MA150	150	1500	LC1D115●●

(1) Standard power ratings for 400 V 50/60 Hz 4-pole motors.

The values expressed in HP conform to the NEC (National Electrical Code).

(2) For references to be completed, replace the dot with the letter corresponding to the breaking performance of the circuit breaker (B, F, N, H, S, or L). Breaking capacity of circuit breakers according to standard IEC 60947-2:

Circuit breaker	I _{cu} (kA) for 440 V	Icu (kA) for 440 V					
		B	F	N	H	S	L
GV2L08...L10	100	–	–	–	–	–	–
GV2L14...L20	20	–	–	–	–	–	–
GV3L25...L65	50	–	–	–	–	–	–
GV4L/LE80...115	–	20	–	50	–	70	–
NSX160●●MA150	–	–	35	50	65	90	130

(3) Composition of contactors:

LC1D09...D115: 3 poles + 1 NO auxiliary contact + 1 NC auxiliary contact

To add auxiliary contacts or other accessories, please refer to the "TeSys - Motor control and protection components" catalog.

(4) Replace ●● with the control circuit voltage code indicated in the table below:

Circuit breaker	Volts ~	24	48	110	220	230	240
		LC1D09...D115	50 Hz	B5	E5	F5	M5
	60 Hz	B6	E6	F6	M6	–	U6
	50/60 Hz	B7	E7	F7	M7	P7	U7

For other voltages available between 24 V ~ and 660 V ~, or a DC control circuit, please contact our [Customer Care Center](#).

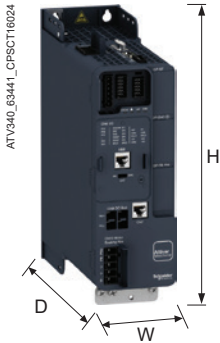

Modular drives

Three-phase supply voltage: 380...480 V 50/60 Hz

Overall dimensions

Drives	W x H x D (1)	
	mm	in.
ATV340U07N4	85 x 270 x 232.5	3.35 x 10.63 x 9.15
With EMC plate	85 x 398 x 232.5	3.35 x 15.67 x 9.15
ATV340U15N4	85 x 270 x 232.5	3.35 x 10.63 x 9.15
With EMC plate	85 x 398 x 232.5	3.35 x 15.67 x 9.15
ATV340U22N4	85 x 270 x 232.5	3.35 x 10.63 x 9.15
With EMC plate	85 x 398 x 232.5	3.35 x 15.67 x 9.15
ATV340U30N4	85 x 270 x 232.5	3.35 x 10.63 x 9.15
With EMC plate	85 x 398 x 232.5	3.35 x 15.67 x 9.15
ATV340U40N4	85 x 270 x 232.5	3.35 x 10.63 x 9.15
With EMC plate	85 x 398 x 232.5	3.35 x 15.67 x 9.15
ATV340U55N4	110 x 270 x 234	4.33 x 10.63 x 9.21
With EMC plate	110 x 398 x 234	4.33 x 15.67 x 9.21
ATV340U75N4	110 x 270 x 234	4.33 x 10.63 x 9.21
With EMC plate	110 x 398 x 234	4.33 x 15.67 x 9.21
ATV340D11N4	180 x 385 x 249	7.09 x 15.16 x 9.80
With EMC plate	180 x 541 x 249	7.09 x 21.30 x 9.80
ATV340D15N4	180 x 385 x 249	7.09 x 15.16 x 9.80
With EMC plate	180 x 541 x 249	7.09 x 21.30 x 9.80
ATV340D18N4	180 x 385 x 249	7.09 x 15.16 x 9.80
With EMC plate	180 x 541 x 249	7.09 x 21.30 x 9.80
ATV340D22N4	180 x 385 x 249	7.09 x 15.16 x 9.80
With EMC plate	180 x 541 x 249	7.09 x 21.30 x 9.80

(1) The total depth excludes the option modules, + 20 mm/0.79 in. depth if combined with the option module. For a cabinet installation that uses front wiring for an option module, + 60 mm/2.36 in. depth is required. Front wiring used for ATV340U07...D22N4 drives.

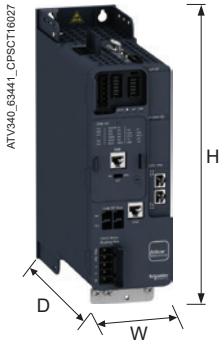

Ethernet-embedded drives
Three-phase supply voltage: 380...480 V 50/60 Hz

Overall dimensions

Drives	W x H x D	
	mm	in.
ATV340U07N4E	85 x 270 x 232.5	3.35 x 10.63 x 9.15
With EMC plate	85 x 398 x 232.5	3.35 x 15.67 x 9.15
ATV340U15N4E	85 x 270 x 232.5	3.35 x 10.63 x 9.15
With EMC plate	85 x 398 x 232.5	3.35 x 15.67 x 9.15
ATV340U22N4E	85 x 270 x 232.5	3.35 x 10.63 x 9.15
With EMC plate	85 x 398 x 232.5	3.35 x 15.67 x 9.15
ATV340U30N4E	85 x 270 x 232.5	3.35 x 10.63 x 9.15
With EMC plate	85 x 398 x 232.5	3.35 x 15.67 x 9.15
ATV340U40N4E	85 x 270 x 232.5	3.35 x 10.63 x 9.15
With EMC plate	85 x 398 x 232.5	3.35 x 15.67 x 9.15
ATV340U55N4E	110 x 270 x 234	4.33 x 10.63 x 9.21
With EMC plate	110 x 398 x 234	4.33 x 15.67 x 9.21
ATV340U75N4E	110 x 270 x 234	4.33 x 10.63 x 9.21
With EMC plate	110 x 398 x 234	4.33 x 15.67 x 9.21
ATV340D11N4E	180 x 385 x 249	7.09 x 15.16 x 9.80
With EMC plate	180 x 541 x 249	7.09 x 21.30 x 9.80
ATV340D15N4E	180 x 385 x 249	7.09 x 15.16 x 9.80
With EMC plate	180 x 541 x 249	7.09 x 21.30 x 9.80
ATV340D18N4E	180 x 385 x 249	7.09 x 15.16 x 9.80
With EMC plate	180 x 541 x 249	7.09 x 21.30 x 9.80
ATV340D22N4E	180 x 385 x 249	7.09 x 15.16 x 9.80
With EMC plate	180 x 541 x 249	7.09 x 21.30 x 9.80
ATV340D30N4E	213 x 660 x 262	8.39 x 25.98 x 10.31
ATV340D37N4E	213 x 660 x 262	8.39 x 25.98 x 10.31
ATV340D45N4E	271 x 908 x 309	10.67 x 35.75 x 12.17
ATV340D55N4E	271 x 908 x 309	10.67 x 35.75 x 12.17
ATV340D75N4E	271 x 908 x 309	10.67 x 35.75 x 12.17

Variable speed drives

Altivar Machine ATV340

Drives, options

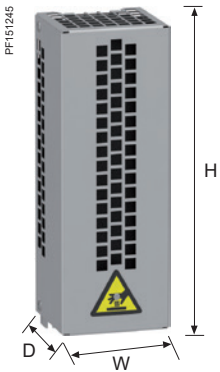
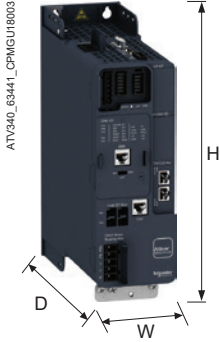

Sercos-embedded drives

Three-phase supply voltage: 380...480 V 50/60 Hz

Overall dimensions		
Drives	W x H x D	
	mm	in.
ATV340U07N4S	85 x 270 x 232.5	3.35 x 10.63 x 9.15
With EMC plate	85 x 398 x 232.5	3.35 x 15.67 x 9.15
ATV340U15N4S	85 x 270 x 232.5	3.35 x 10.63 x 9.15
With EMC plate	85 x 398 x 232.5	3.35 x 15.67 x 9.15
ATV340U22N4S	85 x 270 x 232.5	3.35 x 10.63 x 9.15
With EMC plate	85 x 398 x 232.5	3.35 x 15.67 x 9.15
ATV340U30N4S	85 x 270 x 232.5	3.35 x 10.63 x 9.15
With EMC plate	85 x 398 x 232.5	3.35 x 15.67 x 9.15
ATV340U40N4S	85 x 270 x 232.5	3.35 x 10.63 x 9.15
With EMC plate	85 x 398 x 232.5	3.35 x 15.67 x 9.15
ATV340U55N4S	110 x 270 x 234	4.33 x 10.63 x 9.21
With EMC plate	110 x 398 x 234	4.33 x 15.67 x 9.21
ATV340U75N4S	110 x 270 x 234	4.33 x 10.63 x 9.21
With EMC plate	110 x 398 x 234	4.33 x 15.67 x 9.21
ATV340D11N4S	180 x 385 x 249	7.09 x 15.16 x 9.80
With EMC plate	180 x 541 x 249	7.09 x 21.30 x 9.80
ATV340D15N4S	180 x 385 x 249	7.09 x 15.16 x 9.80
With EMC plate	180 x 541 x 249	7.09 x 21.30 x 9.80
ATV340D18N4S	180 x 385 x 249	7.09 x 15.16 x 9.80
With EMC plate	180 x 541 x 249	7.09 x 21.30 x 9.80
ATV340D22N4S	180 x 385 x 249	7.09 x 15.16 x 9.80
With EMC plate	180 x 541 x 249	7.09 x 21.30 x 9.80

Braking resistors

Overall dimensions		
Braking resistors	W x H x D	
	mm	in.
VW3A7730	105 x 295 x 100	4.13 x 11.61 x 3.94
VW3A7731	105 x 345 x 100	4.13 x 13.58 x 3.94
VW3A7732	175 x 345 x 100	6.89 x 13.58 x 3.94
VW3A7733	190 x 570 x 180	7.48 x 22.44 x 7.09
VW3A7734	250 x 490 x 180	9.84 x 19.29 x 7.09
VW3A7735	250 x 490 x 180	9.84 x 19.29 x 7.09
VW3A7736	485 x 410 x 485	19.09 x 16.14 x 19.09
VW3A7740	105 x 465 x 100	4.13 x 18.31 x 3.94
VW3A7741	175 x 465 x 100	6.89 x 18.31 x 3.94
VW3A7742	190 x 570 x 180	7.48 x 22.44 x 7.09
VW3A7743	290 x 570 x 180	11.42 x 22.44 x 7.09
VW3A7744	450 x 490 x 180	17.72 x 19.29 x 7.09
VW3A7745	485 x 610 x 485	19.09 x 24.02 x 19.09
VW3A7746	485 x 610 x 485	19.09 x 24.02 x 19.09
VW3A7750	290 x 570 x 180	11.42 x 22.44 x 7.09
VW3A7751	390 x 570 x 180	15.35 x 22.44 x 7.09
VW3A7752	485 x 610 x 485	19.09 x 24.02 x 19.09
VW3A7753	485 x 1020 x 605	19.09 x 40.16 x 23.82
VW3A7754	485 x 820 x 1035	19.09 x 32.28 x 40.75
VW3A7755	485 x 1020 x 1035	19.09 x 40.16 x 40.75
VW3A7756	485 x 1020 x 1285	19.09 x 40.16 x 50.59

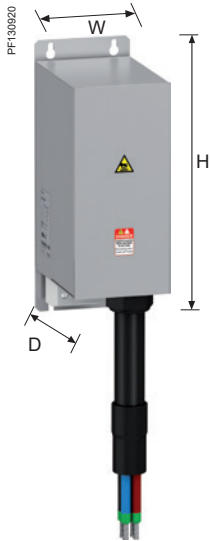

ATV Regenerative units

Overall dimensions

ATV Regenerative units	W x H x D	
	mm	in.
ATVRD15N4	105 x 399 x 235	4.13 x 15.71 x 9.25
ATVRU75N4	80 x 337 x 175	3.15 x 13.27 x 6.89

Additional EMC filters

Overall dimensions

EMC filters	W x H x D	
	mm	in.
VW3A4422	107 x 195 x 42	4.21 x 7.68 x 1.65
VW3A4423	140 x 235 x 50	5.51 x 9.25 x 1.97
VW3A4706	120 x 340 x 180	4.72 x 13.39 x 7.09
VW3A4707	130 x 395 x 240	5.12 x 15.55 x 9.45
VW3A4708	200 x 445 x 320	7.87 x 17.52 x 12.60
VW3A4711	90 x 285 x 170	3.54 x 11.22 x 6.69
VW3A4712	100 x 330 x 180	3.94 x 12.99 x 7.09

Line chokes

Overall dimensions

Motor chokes	W x H x D	
	mm	in.
VW3A4551	100 x 135 x 60	3.94 x 5.31 x 2.36
VW3A4552	130 x 155 x 90	5.12 x 6.10 x 3.54
VW3A4553	130 x 155 x 90	5.12 x 6.10 x 3.54
VW3A4554	155 x 170 x 135	6.10 x 6.69 x 5.31
VW3A4555	180 x 210 x 165	7.09 x 8.27 x 6.50
VW3A4556	270 x 210 x 180	10.63 x 8.27 x 7.09

dv/dt filters

Overall dimensions

dv/dt filters	W x H x D	
	mm	in.
VW3A5301	285 x 530 x 215	10.79 x 20.33 x 8.17
VW3A5302	285 x 530 x 215	10.79 x 20.33 x 8.17
VW3A5303	285 x 530 x 215	10.79 x 20.33 x 8.17
VW3A5304	300 x 560 x 245	11.44 x 21.32 x 9.35
VW3A5305	300 x 610 x 245	11.44 x 23.09 x 9.35
VW3A5306	380 x 325 x 235	14.57 x 8.82 x 12.43

Common mode filters

Overall dimensions

Common mode filters	W x H x D	
	mm	in.
VW3A5501	66 x 119.2 x 66	2.60 x 4.69 x 2.60
VW3A5502	66 x 163.8 x 66	2.60 x 6.45 x 2.60
VW3A5503	127.5 x 161 x 127.5	5.02 x 6.34 x 5.02
VW3A5504	127.5 x 210 x 127.5	5.02 x 8.27 x 5.02

Variable speed drives

Altivar Machine

A whole world of Services for your Drives by Schneider Electric



Drives support and services offer by Schneider Electric

Variable speed drives are an important part of your operation, with downtime having a significant impact on your business. Protecting that investment through comprehensive drive services means that you can continue to deliver to the max throughout the lifecycle of your drive. Our range of services are designed to help you get more out of your drives – and your operation.

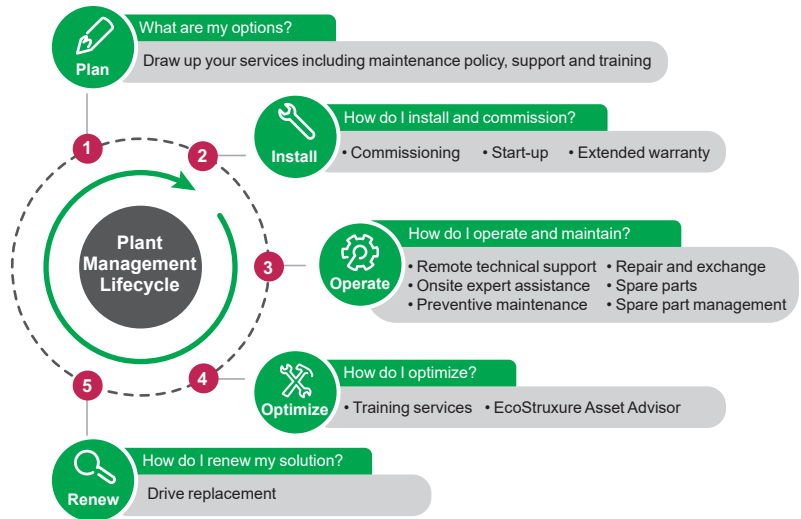

Install

- The **Extended Warranty** service helps you control your maintenance costs. Schneider Electric will provide you a replacement drive or repair the drive on site during the extended warranty period of 3 or 5 years under all conditions covered by the extended warranty.
- The **Start-up** service is the first essential step in maintenance and optimal operational performance of the drive. Our comprehensive review checks up to 100 parameters and is especially designed for drives in simple applications.
- The **Commissioning** service ensures a reliable start for operations with more complex applications and drive systems. The unique requirements of your process need to be carefully considered to ensure efficient operations.



Operate

- The **Preventive Maintenance** service performs predetermined maintenance actions according to the drive product's specific schedule. The work is carried out by certified technical experts following Schneider Electric instructions. The service minimizes unplanned downtime and extends your equipment lifetime.
- The **Remote Technical Support** service offers you expert product assistance over the phone, via email, chat or web on any technical issue such as configuring, diagnosing, and maintaining your drives. Our global support team is multi-lingual with support available from experts up to R&D level if needed.
- The **On-Site Expert Assistance** service provides you with highly skilled field service experts to troubleshoot and resolve drive equipment issues at your site, as expert backup for your personnel.
- A **Repair and Replacement** service is available. The affected drive can be replaced, repaired on site or at our repair centers, depending on the type of drive in question.
- **Spare Parts** are available from our local, regional and global stocks. Original equipment parts from Schneider Electric are reliable and easily available.
- The **Spare Part Management** service identifies and manages your critical spare parts either on your site or offsite. This service ensures you can access spares without needing to invest capital in order to maintain stocks.

Variable speed drives

Altivar Machine

A whole world of Services for your Drives by Schneider Electric



Drives support and services offer by Schneider Electric (continued)

Optimize

- The **Training** service gives your personnel the skills to perform technical installation, commissioning, and maintenance through eLearning sessions, classroom-based and onsite training courses. Enhanced skills lead to better process efficiency and reliability as well as employee satisfaction.
- The **EcoStruxure Asset Advisor** service enables you to move from reactive to predictive maintenance and to access actionable insight provided by the advisor. The service predicts drive and motor problems through connected devices and advanced algorithms monitored by Schneider Electric's experts.

Renew

- The **Drive replacement** means reliable modernization of equipment by replacing the previous aged or obsolete drive with a new one that is fit for purpose. The service can be extended with an engineering option if the device and process require more advanced engineering.

Service contracts: secure recovery, availability and outcome

The **Service contract** ensures your assets' safety and performance is managed through a well-defined maintenance plan that suits your operational needs. The predefined service contract – Advantage Service Plan – and fully customizable A La Carte service contract are built from the services in the “Operate” and “Optimize” phases and service levels defining availability, response and lead times to suit your particular needs. You will enjoy priority access to Schneider Electric support when you need it, as well as having an expert partner to plan the long-term evolution of your drives.

mySchneider app

With the mySchneider app you have easy 24/7 access to product information and expert support. All registered users have access to additional features, such as real-time notifications, order tracking, product pricing and availability. The mySchneider app is available for download from the IOS and Android app store.

Schneider Electric – helping you succeed

Schneider Electric, the leader in digital transformation of energy management and automation, has operations in more than 100 countries. With this global reach we have certified drives field service representatives, offering regional expert and advanced level support up to product R&D to provide you with the best support throughout the lifecycle of your drives. Furthermore, we offer an extensive network of local and global repair centers and a logistics supply chain that ensures our capability to respond.

To order the services and find out more, please contact your local Schneider Electric service center.

#	
490NTC00005	38
490NTC00005U	38
490NTC00015	38
490NTC00015U	38
490NTW00002	38
490NTW00002U	38
490NTW00005	38
490NTW00005U	38
490NTW00012	38
490NTW00012U	38

A

ATV340D11N4	20
ATV340D11N4E	21
ATV340D11N4S	22
ATV340D15N4	20
ATV340D15N4E	21
ATV340D15N4S	22
ATV340D18N4	20
ATV340D18N4E	21
ATV340D18N4S	22
ATV340D22N4	20
ATV340D22N4E	21
ATV340D22N4S	22
ATV340D30N4E	21
ATV340D37N4E	21
ATV340D45N4E	21
ATV340D55N4E	21
ATV340D75N4E	21
ATV340U07N4	20
ATV340U07N4E	21
ATV340U07N4S	22
ATV340U15N4	20
ATV340U15N4E	21
ATV340U15N4S	22
ATV340U22N4	20
ATV340U22N4E	21
ATV340U22N4S	22
ATV340U30N4	20
ATV340U30N4E	21
ATV340U30N4S	22
ATV340U40N4	20
ATV340U40N4E	21
ATV340U40N4S	22
ATV340U55N4	20
ATV340U55N4E	21
ATV340U55N4S	22
ATV340U75N4	20
ATV340U75N4E	21
ATV340U75N4S	22
ATVRD15N4	53
ATVRU75N4	53

L

LU9GC3	37
--------	----

N

NSYPTDS4	23
NSYPTDS5	23

T

TCSCAR01NM120	40
---------------	----

TCSCAR013M120	39
TCSCCTN023F13M03	39
TCSCCTN026M16M	40
TCSEGW13FA0	27
TCSMCNAM3M002P	27
TCSWAAC13FB	27
TSXCANCA50	39
TSXCANCA100	39
TSXCANCA300	39
TSXCANCADD1	40
TSXCANCADD03	40
TSXCANCADD3	40
TSXCANCADD5	40
TSXCANCB50	39
TSXCANCB100	39
TSXCANCB300	39
TSXCANCBDD1	40
TSXCANCBDD03	40
TSXCANCBDD3	40
TSXCANCBDD5	40
TSXCANCD50	39
TSXCANCD100	39
TSXCANCD300	39
TSXCANKCDF90T	39
TSXCANKCDF180T	39
TSXCANTDM4	40

V

VW3A1104R10	25
	27
VW3A1104R30	25
	27
VW3A1104R50	25
	27
VW3A1104R100	25
	27
VW3A1111	26
VW3A1112	27
VW3A1113	24
VW3A1114	25
VW3A1115	27
VW3A3203	35
VW3A3204	35
VW3A3420	34
VW3A3422	34
VW3A3423	34
VW3A3424	34
VW3A3601	41
VW3A3607	41
VW3A3608	39
VW3A3609	41
VW3A3618	39
VW3A3619	41
VW3A3627	41
VW3A3628	40
VW3A3800	43
VW3A3802	42
	43
VW3A4422	47
VW3A4423	47
VW3A4430	23
VW3A4431	23
VW3A4432	23
VW3A4551	49

VW3A4552	49
VW3A4553	49
VW3A4554	49
VW3A4555	49
VW3A4556	49
VW3A4706	47
VW3A4707	47
VW3A4708	47
VW3A4711	47
VW3A4712	47
VW3A5301	50
VW3A5302	50
VW3A5303	50
VW3A5304	50
VW3A5305	50
VW3A5306	50
VW3A5401	50
VW3A5402	50
VW3A7730	44
	45
VW3A7731	44
VW3A7732	44
VW3A7733	44
VW3A7734	44
VW3A7735	44
VW3A7736	44
VW3A7740	45
VW3A7741	45
VW3A7742	45
VW3A7743	45
VW3A7744	45
VW3A7745	45
VW3A7746	45
VW3A7750	45
VW3A7751	45
VW3A7752	45
VW3A7753	45
VW3A7754	45
VW3A7755	45
VW3A7756	45
VW3A8115	27
VW3A8306R	37
VW3A8306R03	37
VW3A8306R10	37
VW3A8306R30	37
VW3A8306RC	37
VW3A8306TF03	37
VW3A8306TF10	37
VW3A34001	23
VW3A34002	23
VW3A34003	23
VW3A47804	23
VW3A47805	23
VW3A53901	50
VW3A53902	50
VW3A53903	50
VW3A53904	50
VW3CANCARR1	39
VW3CANCARR03	39
VW3CANKCDF180T	39
VW3CANTAP2	40
VW3E5001R005	38
VW3E5001R010	38

VW3E5001R015	38
VW3E5001R020	38
VW3E5001R030	38
VW3E5001R050	38
VW3E5001R100	38
VW3E5001R150	38
VW3E5001R200	38
VW3E5001R250	38
VW3E5001R300	38
VW3E5001R400	38
VW3E5001R500	38
VW3M2207	23
VW3M2606	23
VW3M3802	39
VW3M4701	34
VW3M7101R01	23
VW3M7102R150	23
VW3M8221R1000	34
VW3M8222R250	34
VW3M8222R500	34
VW3M8222R1000	34
VW3M8223R30	23
VW3M8502R03	23
VW3M8502R15	23
VW3M8801R30	42
VW3M8802R15	42
VW3M8802R30	42
VW3M8810	42
VW3M8820	42
VX5VMS1001	23
VX5VMS2001	23
VX5VMS3001	23
VX5VPS4001	23
VX5VPS5001	23

Z

ZB5AZ905	25
	27

Life Is On



Learn more about our products at
www.schneider-electric.com/drives

The information provided in this documentation contains general descriptions and/or technical characteristics of the performance of the products contained herein. This documentation is not intended as a substitute for and is not to be used for determining suitability or reliability of these products for specific user applications. It is the duty of any such user or integrator to perform the appropriate and complete risk analysis, evaluation and testing of the products with respect to the relevant specific application or use thereof. Neither Schneider Electric nor any of its affiliates or subsidiaries shall be responsible or liable for misuse of the information contained herein.

Design: Schneider Electric
Photos: Schneider Electric

Schneider Electric Industries SAS

Head Office
35, rue Joseph Monier - CS 30323
F-92500 Rueil-Malmaison Cedex
France

DIA2ED2160701EN
March 2020 - V4.0