



Product designation	RFE45
Product type designation	Motor protection relay

General characteristics

Number of poles	nr.	3
Overvoltage category		III
Pollution degree		3
Frontal IP degree		IP20
Type of release		Electronic thermal
Protection fuse		
	gG (IEC)	A 6
	aM (IEC)	A 4
Phase failure detection		yes
Reset mode		manual or automatic

Power circuit characteristics

Rated insulation voltage U_i IEC/EN	V	1000
Rated impulse withstand voltage U_{imp}	kV	6
Rated operational voltage	V	690
Operational frequency		
	min	Hz 50
	max	Hz 60
Operational current I_e		
	Operational current min	A 0.4
	Operational current max	A 2
Tripping class		5 - 10 - 20 - 30
Test Button		yes
Trip indicator		yes

Terminals			
	type		screw and washer
	screw		M4
	width	mm	12
	tool		Phillips 2

Tightening torque for terminals			
	min	Nm	3.1
	Max	Nm	3.1
	min	lbin	2.3
	max	lbin	2.3

Conductor section		
	AWG/kcmil max	6

Auxiliary circuit characteristics

Auxiliary contacts		
	NO	nr. 1

	NC	nr.	1
Auxiliary Rated insulation voltage U_i IEC/EN		V	690
Auxiliary Rated impulse withstand voltage U_{imp}		kV	6
Auxiliary Rated operational voltage		V	690
Operating current AC15			
	24V	A	3
	120V	A	3
	240V	A	1.5
	380V	A	0.95
	480V	A	0.75
	500V	A	0.72
	600V	A	0.6
Operating current DC13			
	125V	A	0.11
	600V	A	0.22
IEC Conventional free air thermal current I_{th}		A	10
Terminals			
	Auxiliary circuit type		screw and washer
	Auxiliary circuit screw		M3,5
	Auxiliary circuit width	mm	7
	Auxiliary circuit tool		Phillips 2
Conductor section			
	Auxiliary circuit Flexible w/o lug max	mm ²	2.5
	Auxiliary circuit Flexible c/w lug max	mm ²	2.5
Tightening torque for terminals			
	Auxiliary circuit min	Nm	0.8
	Auxiliary circuit max	Nm	0.8
	Auxiliary circuit min	lbin	0.6
	Auxiliary circuit max	lbin	0.6
UL/CSA and IEC/EN 60947-5-1 designation			B600-R300
Ambient conditions			
Operating temperature			
	min	°C	-25
	max	°C	70
Storage temperature			
	min	°C	-55
	max	°C	80
Compensation temperature			
	min	°C	-25
	max	°C	70
Max altitude		m	3000
Mechanical features			
Operating position			
	normal allowable		Vertical plan ±30°
Weight		g	195
UL technical data			
Full-load current (FLA) for three-phase AC motor			
	at 480V	A	2
	at 600V	A	2
Dimensions			

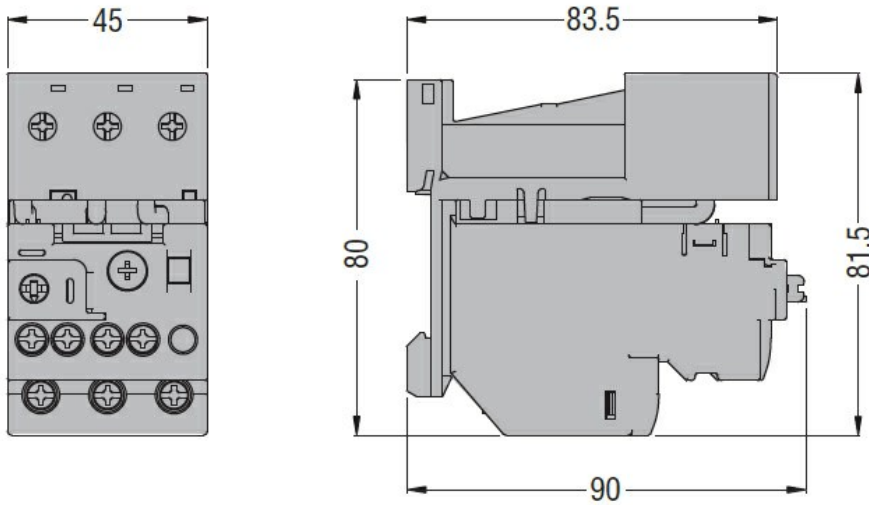

Wiring diagrams

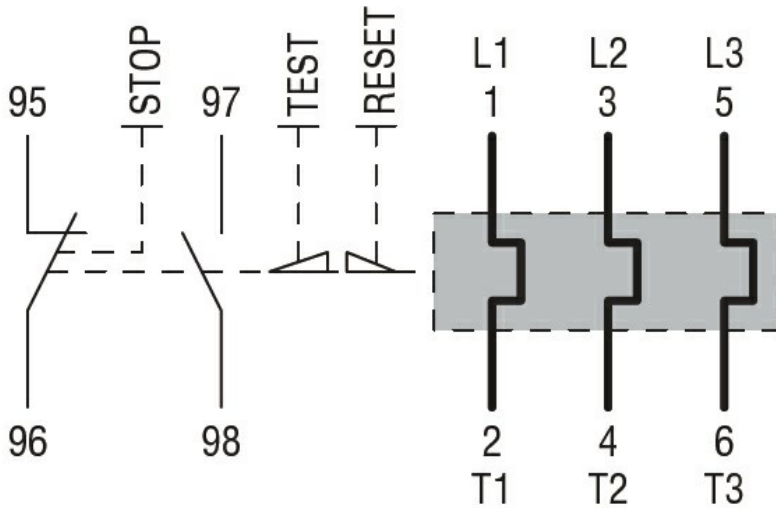

Certifications and compliance

Compliance

CSA C22.2 n° 60947-1
 CSA C22.2 n° 60947-4-1
 IEC/EN 60947-1; IEC/EN 60947-4-1
 UL 60947-1
 UL 60947-4-1

Certifications

cULus