

XUM9ANXB M8

Photoelectric sensors XU, photo electric sensor, miniature, polarised, Smax=8 m, NPN, connector M8



Main

Range of product	Telemecanique Photoelectric sensors XU
Series name	General purpose single mode
Electronic sensor type	Photo-electric sensor
Sensor name	XUM
Sensor design	Miniature
Detection system	Polarised reflex
Material	Plastic
Type of output signal	Discrete
Supply circuit type	DC
Wiring technique	3-wire
Discrete output type	NPN
Discrete output function	1 NO or 1 NC programmable
Electrical connection	Male connector M8, 4 pins
Emission	Red LED polarised reflex
[Sn] nominal sensing distance	6.7 m with reflector 50 x 50 mm

Complementary

Enclosure material	PBT
Lens material	PMMA
Maximum sensing distance	8 m
Output type	Solid state
Status LED	Stability: 1 LED (green) Output state: 1 LED (orange)
[Us] rated supply voltage	12...24 V DC with reverse polarity protection
Supply voltage limits	10...30 V DC
Switching capacity in mA	<= 100 mA with overload and short-circuit protection
Switching frequency	<= 1000 Hz
Maximum voltage drop	<2 V
Current consumption	20 mA no-load
Maximum delay first up	100 ms
Maximum delay response	0.5 ms
Maximum delay recovery	0.5 ms
Setting-up	Sensitivity by potentiometer
Depth	20 mm
Height	44 mm
Width	10 mm
Net weight	0.01 kg

Environment

Product certifications	cULus[RETURN]CE[RETURN]UKCA
Ambient air temperature for operation	-30...55 °C
Ambient air temperature for storage	-40...70 °C
Relative humidity	35...95 %
Immunity to ambient light	40000 Lux sunlight 10000 lux incandescent light

Vibration resistance	9 gn, amplitude = +/- 1.5 mm (f = 10...500 Hz) for every axis conforming to IEC 60068-2-6
Shock resistance	100 gn (duration = 11 ms) for every axis conforming to IEC 60068-2-27
IP degree of protection	IP67 conforming to IEC 60529 IP65 conforming to IEC 60529

Packing Units

Unit Type of Package 1	PCE
Number of Units in Package 1	1
Package 1 Height	1 cm
Package 1 Width	2.5 cm
Package 1 Length	4.5 cm
Package 1 Weight	13 g
Unit Type of Package 2	S02
Number of Units in Package 2	120
Package 2 Height	15 cm
Package 2 Width	30 cm
Package 2 Length	40 cm
Package 2 Weight	2.048 kg

Offer Sustainability

California proposition 65	WARNING: This product can expose you to chemicals including: Diisononyl phthalate (DINP), which is known to the State of California to cause cancer, and Di-isodecyl phthalate (DIDP), which is known to the State of California to cause birth defects or other reproductive harm. For more information go to www.P65Warnings.ca.gov
For all Reach Rohs enquiries contact us at	sustainability@tesensors.com

Contractual warranty

Warranty	18 months
----------	-----------

Dimensions

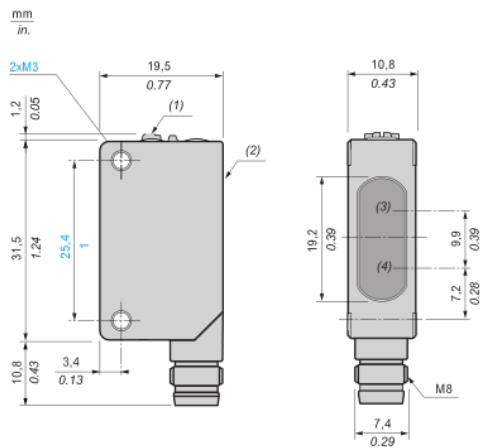

- (1) : Setting potentiometer (sensitivity)
- (2) : Setting potentiometer (output)
- (3) : Reception
- (4) : Transmission

Connection and schema

Wiring diagram

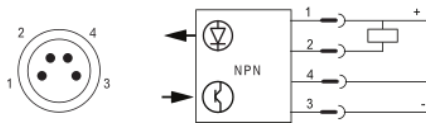

- 1 : (+)
- 2 : Not connected
- 3 : (-)
- 4 : OUT/Output

Detection curves

Reflector angle

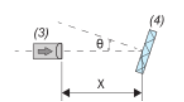
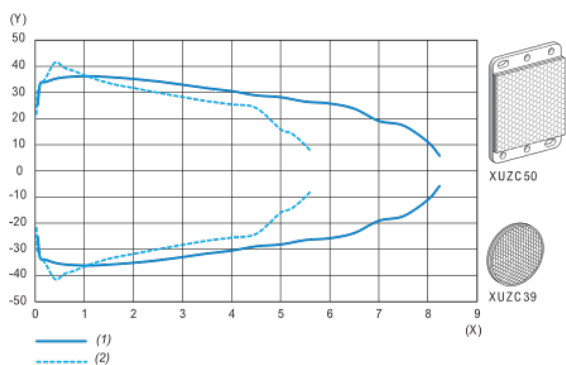

- (1) : Using XUZC50 reflector
- (2) : Using XUZC39 reflector
- (3) : Sensor
- (4) : Reflector
- (X) : Sensing distance (m)
- (Y) : Reflector angle θ ($^{\circ}$)

Lateral displacement

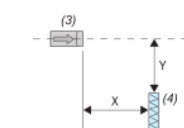
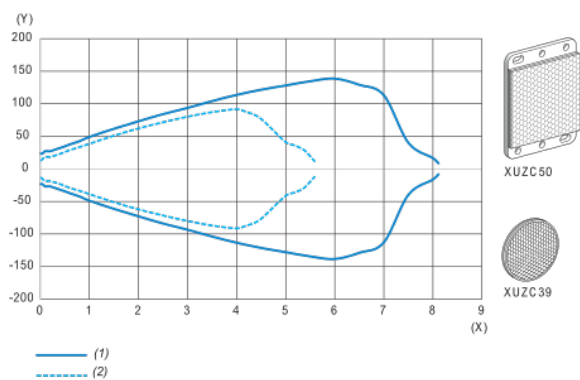

- (1) : Using XUZC50 reflector
- (2) : Using XUZC39 reflector
- (3) : Sensor
- (4) : Reflector
- (X) : Sensing distance (m)
- (Y) : Lateral displacement (mm)

Excess gain

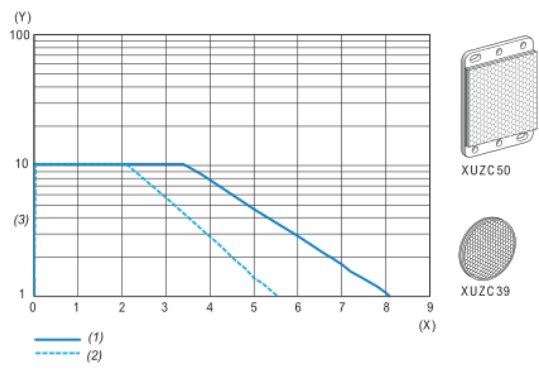

(1) : Using XUZC50 reflector

(2) : Using XUZC39 reflector

(3) : Operation level

(X) : Sensing distance (m)

(Y) : Excess gain