

# XUM8APXBM8

Photoelectric sensors XU, miniature, background suppression, Smax=0.30 m, PNP, connector M8



## Main

Range of product	Telemecanique Photoelectric sensors XU
Series name	General purpose single mode
Electronic sensor type	Photo-electric sensor
Sensor name	XUM
Sensor design	Miniature
Detection system	Diffuse with background suppression
Material	Plastic
Type of output signal	Discrete
Supply circuit type	DC
Wiring technique	3-wire
Discrete output type	PNP
Discrete output function	1 NO or 1 NC programmable
Electrical connection	Male connector M8, 4 pins
Emission	Red LED diffuse with background suppression
[Sn] nominal sensing distance	0.20 m

## Complementary

Enclosure material	PBT
Lens material	PMMA
Maximum sensing distance	0.30 m
Output type	Solid state
Status LED	Stability: 1 LED (green) Output state: 1 LED (orange)
[Us] rated supply voltage	12...24 V DC with reverse polarity protection
Supply voltage limits	10...30 V DC
Switching capacity in mA	<= 100 mA with overload and short-circuit protection
Switching frequency	<= 1000 Hz
Maximum voltage drop	<2 V (closed state)
Current consumption	30 mA no-load
Maximum delay first up	100 ms
Maximum delay response	0.5 ms
Maximum delay recovery	0.5 ms
Setting-up	Sensitivity by potentiometer
Depth	27 mm
Height	44 mm
Width	10 mm
Net weight	0.01 kg

## Environment

Product certifications	cULus[RETURN]CE[RETURN]UKCA
Ambient air temperature for operation	-30...55 °C
Ambient air temperature for storage	-40...70 °C
Relative humidity	35...95 %
Immunity to ambient light	40000 Lux sunlight 10000 lux incandescent light

Vibration resistance	9 gn, amplitude = +/- 1.5 mm (f = 10...500 Hz)for every axis conforming to IEC 60068-2-6
Shock resistance	100 gn (duration = 11 ms) for for every axis conforming to IEC 60068-2-27
IP degree of protection	IP67 conforming to IEC 60529 IP65 conforming to IEC 60529

### Packing Units

Unit Type of Package 1	PCE
Number of Units in Package 1	1
Package 1 Height	2 cm
Package 1 Width	9 cm
Package 1 Length	12 cm
Package 1 Weight	12 g

### Offer Sustainability

California proposition 65	WARNING: This product can expose you to chemicals including: Diisononyl phthalate (DINP), which is known to the State of California to cause cancer, and Di-isodecyl phthalate (DIDP), which is known to the State of California to cause birth defects or other reproductive harm. For more information go to <a href="http://www.P65Warnings.ca.gov">www.P65Warnings.ca.gov</a>
For all Reach Rohs enquiries contact us at	<a href="mailto:sustainability@tesensors.com">sustainability@tesensors.com</a>

### Contractual warranty

Warranty	18 months
----------	-----------

## Dimensions

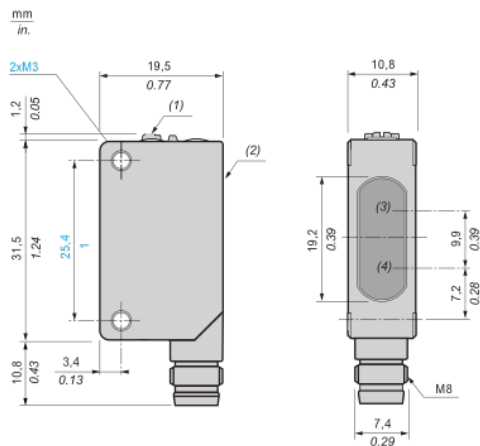

- (1) : Setting potentiometer (sensitivity)
- (2) : Setting potentiometer (output)
- (3) : Reception
- (4) : Transmission

---

## Connection and schema

---

### Wiring diagram

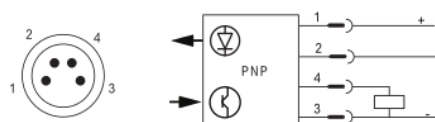

- 1 : (+)
- 2 : Not connected
- 3 : (-)
- 4 : OUT/Output

Detection curves

Lateral displacement (preset 100 mm)

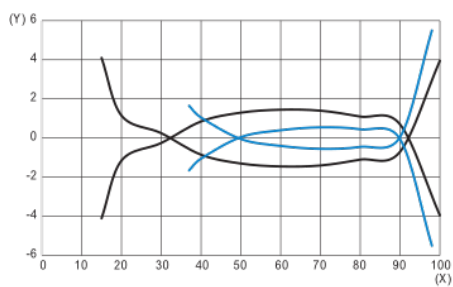

(1)  
(2)

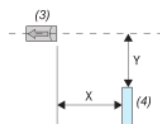

- (1) : Black paper 6 % remission
- (2) : White paper 90 % remission
- (3) : Sensor
- (4) : Object (200 mm square white and black mat paper)
- (X) : Sensing distance (mm)
- (Y) : Lateral displacement (mm)

Lateral displacement (preset 200 mm)

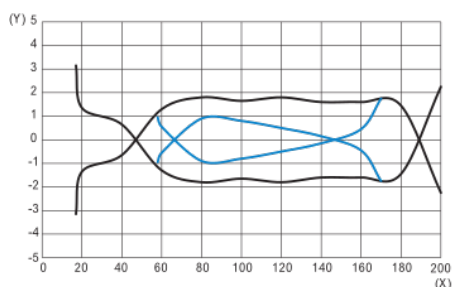

(1)  
(2)

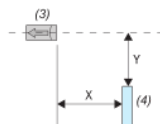

- (1) : Black paper 6 % remission
- (2) : White paper 90 % remission
- (3) : Sensor
- (4) : Object (200 mm square white and black mat paper)
- (X) : Sensing distance (mm)
- (Y) : Lateral displacement (mm)

## Light beam diameter

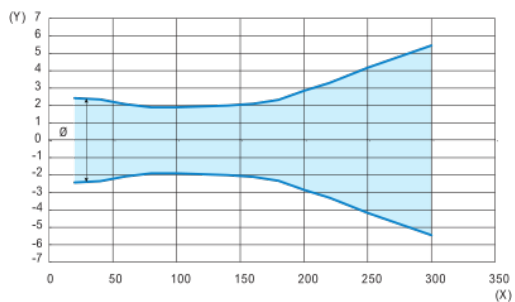

(X) : Sensing distance (mm)

(Y) : Light beam diameter (mm)

## Minimum distance between the object to detect and white background

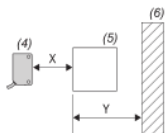
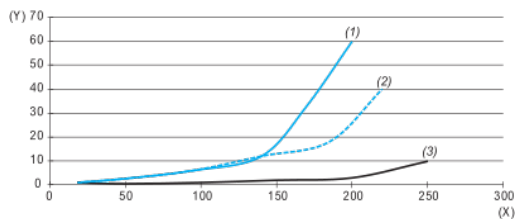

(1) : Min. distance black object (6%)/white background (90%) (mm)

(2) : Min. distance grey object (18%)/white background (90%) (mm)

(3) : Min. distance white object (90%)/white background (90%) (mm)

(4) : Sensor

(5) : Object

(6) : Background

(X) : Distance sensor/object (mm)

(Y) : Min. distance object/background (mm)