

# XUM6ANXB2

Photoelectric sensors XU, miniature, diffuse medium, Smax=1.1 m, NPN, cable 2 m



## Main

Range of product	Telemecanique Photoelectric sensors XU
Series name	General purpose single mode
Electronic sensor type	Photo-electric sensor
Sensor name	XUM
Sensor design	Miniature
Detection system	Diffuse
Material	Plastic
Type of output signal	Discrete
Supply circuit type	DC
Wiring technique	3-wire
Discrete output type	NPN
Discrete output function	1 NO or 1 NC programmable
Electrical connection	Cable
Cable length	2 m
Emission	Red LED diffuse
[Sn] nominal sensing distance	0.8 m

## Complementary

Enclosure material	PBT
Lens material	PMMA
Maximum sensing distance	1.1 m
Output type	Solid state
Wire insulation material	PVC
Status LED	Stability: 1 LED (green) Output state: 1 LED (orange)
[Us] rated supply voltage	12...24 V DC with reverse polarity protection
Supply voltage limits	10...30 V DC
Switching capacity in mA	<= 100 mA with overload and short-circuit protection
Switching frequency	<= 1000 Hz
Maximum voltage drop	<2 V
Current consumption	20 mA no-load
Maximum delay first up	100 ms
Maximum delay response	0.5 ms
Maximum delay recovery	0.5 ms
Setting-up	Sensitivity by potentiometer
Depth	20 mm
Height	33 mm
Width	10 mm
Net weight	0.063 kg

## Environment

Product certifications	cULus[RETURN]CE[RETURN]UKCA
Ambient air temperature for operation	-30...55 °C
Ambient air temperature for storage	-40...70 °C
Relative humidity	35...95 %
Immunity to ambient light	40000 Lux sunlight 10000 lux incandescent light

Vibration resistance	9 gn, amplitude = +/- 1.5 mm (f = 10...500 Hz) for every axis conforming to IEC 60068-2-6
Shock resistance	100 gn (duration = 11 ms) for every axis conforming to IEC 60068-2-27
IP degree of protection	IP67 conforming to IEC 60529 IP65 conforming to IEC 60529

## Packing Units

Unit Type of Package 1	PCE
Number of Units in Package 1	1
Package 1 Height	1.5 cm
Package 1 Width	12 cm
Package 1 Length	12 cm
Package 1 Weight	50 g
Unit Type of Package 2	S04
Number of Units in Package 2	160
Package 2 Height	30 cm
Package 2 Width	40 cm
Package 2 Length	60 cm
Package 2 Weight	9.85 kg

## Offer Sustainability

California proposition 65	WARNING: This product can expose you to chemicals including: Diisononyl phthalate (DINP), which is known to the State of California to cause cancer, and Di-isodecyl phthalate (DIDP), which is known to the State of California to cause birth defects or other reproductive harm. For more information go to <a href="http://www.P65Warnings.ca.gov">www.P65Warnings.ca.gov</a>
For all Reach Rohs enquiries contact us at	<a href="mailto:sustainability@tesensors.com">sustainability@tesensors.com</a>

## Contractual warranty

Warranty	18 months
----------	-----------

## Dimensions

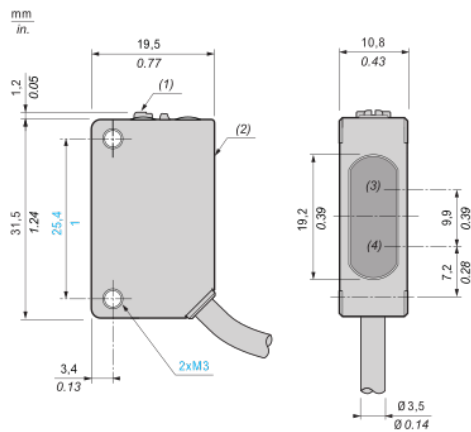

- (1) : Setting potentiometer (sensitivity)
- (2) : Setting potentiometer (output)
- (3) : Reception
- (4) : Transmission

---

## Connection and schema

---

### Wiring diagram

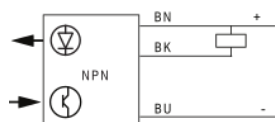

BN (Brown) : (+)

BK (Black) : OUT/Output

BU (Blue) : (-)

Detection curves

Object size/sensing distance

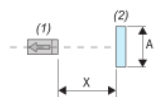
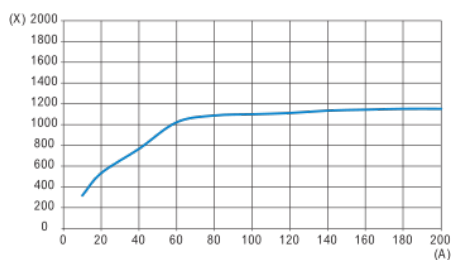

- (1) : Sensor
- (2) : Object (white mat paper of A mm square)
- (A) : Side length (mm)
- (X) : Sensing distance (mm)

Lateral displacement

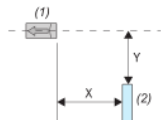
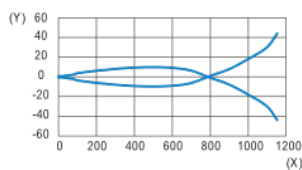

- (1) : Sensor
- (2) : Object (200 x 200 mm square white paper)
- (X) : Sensing distance (mm)
- (Y) : Lateral displacement (mm)

Excess gain

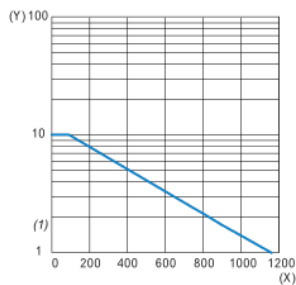

- (1) : Operation level
- (X) : Sensing distance (m)
- (Y) : Excess gain