

XCMN21F2L1

Limit switch, Limit switches XC Standard, XCMN, M12 steel roller plunger, 1NC+1 NO, snap, 1 m



Main

Range of product	Telemecanique Limit switches XC Standard
Series name	Standard format
Product or component type	Limit switch
Device short name	XCMN
Sensor design	Miniature
Body type	Fixed
Head type	M12 plunger head
Material	Plastic
Body material	Plastic
Head material	Zamak
Fixing mode	By the head
Movement of operating head	Linear
Type of operator	Spring return roller plunger metal
Type of approach	Lateral approach, 2 directions
Number of poles	2
Contacts type and composition	1 NC + 1 NO
Contact operation	Snap action

Complementary

Switch actuation	By 30° cam
Electrical connection	Fixed cable
Cable length	1 m
Cable composition	4 x 0.75 mm ²
Wire insulation material	PvR
Contacts insulation form	Zb
Positive opening	With
Positive opening minimum force	35 N
Minimum force for tripping	7 N
Maximum actuation speed	10 cm/s
Contact code designation	B300, AC-15 (U _e = 240 V), I _e = 1.5 A conforming to EN/IEC 60947-5-1 appendix A R300, DC-13 (U _e = 250 V), I _e = 0.1 A conforming to EN/IEC 60947-5-1 appendix A
[Ui] rated insulation voltage	300 V (pollution degree 3) conforming to UL 508 400 V (pollution degree 3) conforming to IEC 60947-5-1 300 V (pollution degree 3) conforming to CSA C22.2 No 14
Maximum resistance across terminals	25 MOhm conforming to IEC 60255-7 category 3
[Uimp] rated impulse withstand voltage	4 kV conforming to IEC 60664 4 kV conforming to IEC 60947-1
Short-circuit protection	6 A cartridge fuse, type gG
Electrical durability	5000000 Cycles, DC-13, 120 V, 1 W, operating rate <60 cyc/mn, load factor: 0.5 conforming to IEC 60947-5-1 appendix C 5000000 Cycles, DC-13, 24 V, 3 W, operating rate <60 cyc/mn, load factor: 0.5 conforming to IEC 60947-5-1 appendix C 5000000 cycles, DC-13, 48 V, 2 W, operating rate <60 cyc/mn, load factor: 0.5 conforming to IEC 60947-5-1 appendix C
Mechanical durability	5000000 cycles

The information provided in this documentation contains general descriptions and/or technical characteristics of the performance of the products contained herein. This documentation is not intended as a substitute for and is not to be used for determining suitability or reliability of these products for specific user applications. It is the duty of any such user or integrator to perform the appropriate and complete risk analysis, evaluation and testing of the products with respect to the relevant specific application or use thereof. Neither TWSS Holding nor any of its affiliates or subsidiaries shall be responsible or liable for misuse of the information contained herein.

Width	30 mm
Height	88 mm
Depth	16 mm
Net weight	0.095 kg

Environment

Shock resistance	25 gn for 18 ms conforming to IEC 60068-2-27
Vibration resistance	5 gn (f= 10...500 Hz) conforming to IEC 60068-2-6
IP degree of protection	IP65 conforming to IEC 60529
IK degree of protection	IK04 conforming to EN 50102
Electrical shock protection class	Class II conforming to IEC 61140 Class II conforming to NF C 20-030
Ambient air temperature for operation	-25...70 °C
Ambient air temperature for storage	-40...70 °C
Protective treatment	TC
Product certifications	CSA[RETURN]CCC[RETURN]UL
Standards	EN/IEC 60947-5-1 EN/IEC 60204-1 CSA C22.2 No 14 UL 508

Packing Units

Unit Type of Package 1	PCE
Number of Units in Package 1	1
Package 1 Height	18.0 cm
Package 1 Width	13.0 cm
Package 1 Length	1.8 cm
Package 1 Weight	139.0 g
Unit Type of Package 2	PAL
Number of Units in Package 2	560
Package 2 Height	60.0 cm
Package 2 Width	80.0 cm
Package 2 Length	77.0 cm
Package 2 Weight	94.08 kg
Unit Type of Package 3	S03
Number of Units in Package 3	70
Package 3 Height	30.0 cm
Package 3 Width	30.0 cm
Package 3 Length	40.0 cm
Package 3 Weight	10.443 kg

Offer Sustainability

Sustainable offer status	Green Premium product
Environmental Disclosure	Product Environmental Profile
Circularity Profile	End of Life Information
California proposition 65	WARNING: This product can expose you to chemicals including: Diisononyl phthalate (DINP), which is known to the State of California to cause cancer, and Di-isodecyl phthalate (DIDP), which is known to the State of California to cause birth defects or other reproductive harm. For more information go to www.P65Warnings.ca.gov
For all Reach Rohs enquiries contact us at	sustainability@tesensors.com

Contractual warranty

Warranty	18 months
----------	-----------

Dimensions

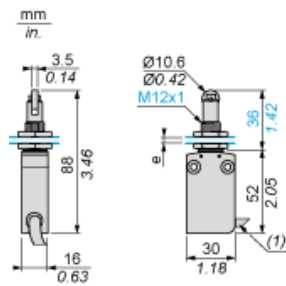

- (1) External diameter 7.5 mm.
- e : 8 mm max, panel cut-out Ø 12.5 mm. Fixing nut thickness 3.5 mm.

Mounting

Sweep of Connecting Cable

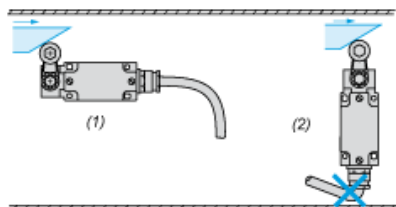

- (1) : Recommended
- (2) : To be avoided

Mounting with Spacers

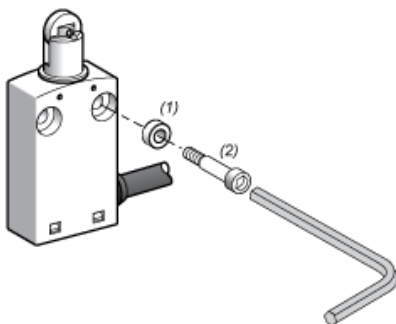

- (1) : 2 spacers supplied with the XCMN switch
- (2) : 2 screws Ø 4mm (not included)

Panel Mounting

Mounting and Fixing Limit Switches by the Head

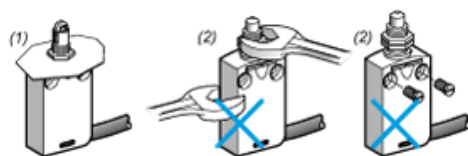

- (1) Recommended
- (2) Forbidden

Setting-up

Plunger or Multi-directional Heads

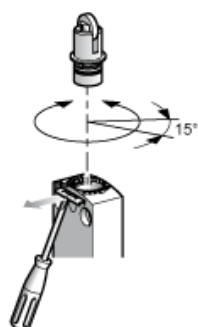

Wiring diagram

2-pole NC + NO Snap Action

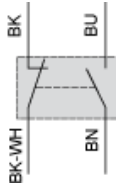

- (BK) Black
- (BK- Black White
WH)
- (BN) Brown
- (BU) Blue

Characteristics of Actuation

Switch Actuation by 30° Cam

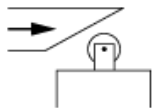

Functionnal Diagram

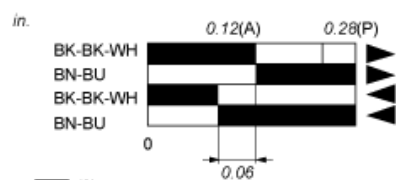
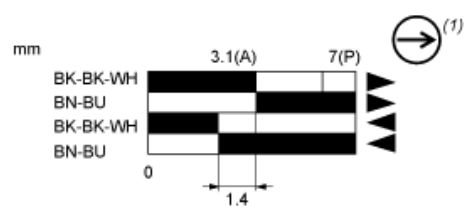

- (2)
- (3)
- ▶ (4)
- ◀ (5)

- (P) Positive opening point
- (A) Cam displacement
- (1) NC contact with positive opening operation
- (2) Closed
- (3) Open
- (4) Tripping
- (5) Resetting
- (BK) Black
- (BK- Black White
- WH)
- (BN) Brown
- (BU) Blue