

XT230A1NAL2

Capacitive proximity sensors XT, cylindrical M30, plastic, Sn 15 mm, cable 2 m



Main

Range of product	Telemecanique Capacitive proximity sensors XT
Sensor type	Capacitive proximity sensor
Product specific application	Detection of insulated or conductive materials
Sensor name	XT2
Sensor design	Cylindrical M30
Size	74.5 mm
Body type	Fixed
Detector flush mounting acceptance	Non flush mountable
Material	Plastic
Enclosure material	Plastic
Type of output signal	Discrete
Wiring technique	3-wire
[Sn] nominal sensing distance	15 mm
Discrete output function	1 NO
Output circuit type	DC
Discrete output type	NPN
Electrical connection	Cable
Cable length	2 m
[Us] rated supply voltage	12...24 V DC with reverse polarity protection
Maximum delay response	10 ms
IP degree of protection	IP67 double insulation conforming to IEC 60529

Complementary

ISO thread	M30 x 1.5
Detection face	Frontal
[Sa] assured operating distance	0...11 mm
Adjustment zone	0...17 mm
Differential travel	< 1...20 % Sr
Repeat accuracy	< 5 % Sr
Wire insulation material	PVC
Status LED	Output state indication: 1 LED (yellow)
Supply voltage limits	10...30 V DC
Maximum residual current	100 mA open state
Protection type	Short-circuit protection
Switching frequency	<= 150 Hz
Maximum voltage drop	<2.5 V (closed)
Current consumption	< 15 mA
Maximum delay first up	100 ms
Maximum delay recovery	10 ms
Maximum switching current	200 mA
Marking	CE
Setting-up	Sensitivity by potentiometer
Threaded length	48.5 mm

The information provided in this documentation contains general descriptions and/or technical characteristics of the performance of the products contained herein. This documentation is not intended as a substitute for and is not to be used for determining suitability or reliability of these products for specific user applications. It is the duty of any such user or integrator to perform the appropriate and complete risk analysis, evaluation and testing of the products with respect to the relevant specific application or use thereof. Neither TWSS Holding nor any of its affiliates or subsidiaries shall be responsible or liable for misuse of the information contained herein.

Length	74.5 mm
Net weight	0.27 kg

Environment

Standards	IEC 60947-5-2
Product certifications	cULus
Ambient air temperature for operation	-10...60 °C
Vibration resistance	10 gn amplitude = 1 mm (f = 10...55 Hz) conforming to IEC 60068-2-6
Shock resistance	30 gn for 11 ms conforming to IEC 60068-2-27
Resistance to electrostatic discharge	4 kV contact conforming to IEC 61000-4-2 8 kV air conforming to IEC 61000-4-2
Resistance to electromagnetic fields	3 V/m conforming to IEC 61000-4-3
Resistance to fast transients	2 kV conforming to IEC 61000-4-4

Packing Units

Unit Type of Package 1	PCE
Number of Units in Package 1	1
Package 1 Height	3.0 cm
Package 1 Width	13.0 cm
Package 1 Length	13.0 cm
Package 1 Weight	160.0 g
Unit Type of Package 2	S02
Number of Units in Package 2	30
Package 2 Height	15.0 cm
Package 2 Width	30.0 cm
Package 2 Length	40.0 cm
Package 2 Weight	5.185 kg

Offer Sustainability

Toxic heavy metal free	Yes
California proposition 65	WARNING: This product can expose you to chemicals including: Diisononyl phthalate (DINP), which is known to the State of California to cause cancer, and Di-isodecyl phthalate (DIDP), which is known to the State of California to cause birth defects or other reproductive harm. For more information go to www.P65Warnings.ca.gov
For all Reach Rohs enquiries contact us at	sustainability@tesensors.com

Contractual warranty

Warranty	18 months
----------	-----------

Dimensions

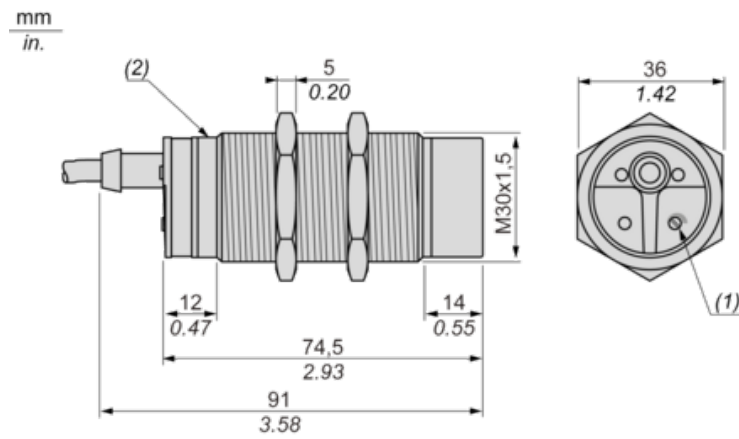

(1) Adjustment potentiometer

(2) LED

Setting-up

Minimum Mounting Distances (mm)

Side by side

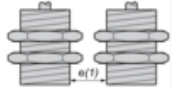

$$e(1) \geq 60$$

Face to face

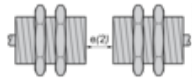

$$e(2) \geq 90$$

Facing a metal object

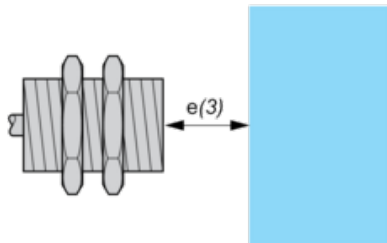

$$e(3) \geq 45$$

Mounted in support

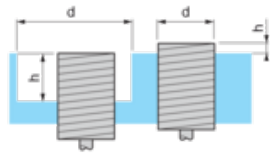

$$d \geq 90$$

$$h \geq 30$$

Fixing nut tightening torque: 8 N.m

Adjustment

Sensitivity Adjustment

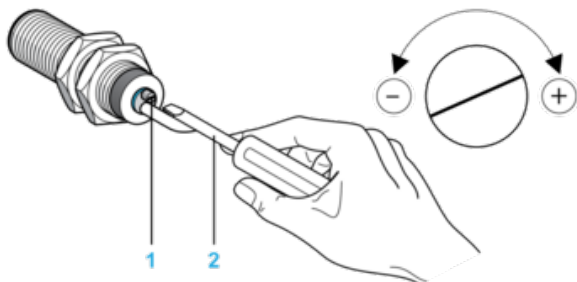

(1) Adjustment potentiometer

(2) Screwdriver (included with sensor)

Wiring Diagram

Pre-cabled

3-wire DC, NPN NO Output

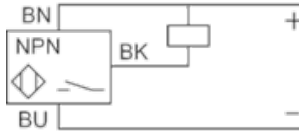

(BU) Blue

(BN) Brown

(BK) Black