

XY2CJS15

Latching emergency stop rope pull switch,
Telemecanique rope pull switches XY2C, e
XY2CJ, straight, 1NC+1 NO, Pg13.5

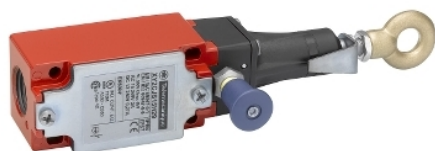

Main

Range of product	Telemecanique Emergency stop rope pull switches XY2C
Product or component type	Latching emergency stop rope pull switch
Device short name	XY2C
Housing colour	Red RAL 3000
Overvoltage category	Class I conforming to EN/IEC 61140

Complementary

Local signalling	Color indicator
Number of cables	1
Trigger cable maximum length	20 m
Body material	Zamak
Head material	PA (polyamide)
Cover material	Galvanised steel
Reset	By pull button
Contacts type and composition	1 NC + 1 NO
Contact operation	Slow-break
Trigger cable anchor point	RH or LH side
Connections - terminals	Screw clamp terminal, 1 x 0.5...2 x 1.5 mm ²
Tightening torque	0.8...1.2 N.m
Cable entry number	1 tapped entry for Pg 13.5 cable gland
Safety level	Can reach PL = e with the appropriate monitoring system and correctly wired conforming to EN/ISO 13849-1 Can reach category 4 with the appropriate monitoring system and correctly wired conforming to EN/ISO 13849-1 Can reach SIL 3 with the appropriate monitoring system and correctly wired conforming to EN/IEC 61508
Safety reliability data	B10d = 500000 conforming to IEC 60947-5-5 value given for a life time of 20 years limited by mechanical or contact wear
Marking	CE
Mechanical durability	100000 cycles
Distance between cable supports	5 m
[Ie] rated operational current	3 A at 240 V, AC-15, A300 conforming to EN/IEC 60947-5-1 appendix A 0.27 A at 250 V, DC-13, Q300 conforming to EN/IEC 60947-5-1 appendix A
[Ithe] conventional enclosed thermal current	10 A
[Ui] rated insulation voltage	500 V (pollution degree 3) conforming to EN/IEC 60947-1 300 V conforming to UL 508 300 V conforming to CSA C22.2 No 14
[Uimp] rated impulse withstand voltage	6 kV conforming to EN/IEC 60947-1
Positive opening	With conforming to EN/IEC 60947-5-1
Maximum resistance across terminals	25 MOhm conforming to EN/IEC 60255-7 category 3 25 MOhm conforming to NF C 93-050 method A
Short-circuit protection	10 A cartridge fuse type gG conforming to EN/IEC 60269
Terminals description ISO n°1	(13-14)NO (21-22)NC

Net weight	0.455 kg
Compatibility code	XY2CJ





Environment

Standards	CSA C22.2 No 14 Machinery directive 2006/42/EC EN/IEC 60947-5-5 Work equipment directive 2009/104/EC EN/IEC 60947-5-1 EN/ISO 13850 EN/IEC 60204-1 UL 508
Product certifications	UL category NISD emergency stop devices CSA CCC EAC
Protective treatment	TC
Ambient air temperature for operation	-25...70 °C
Ambient air temperature for storage	-40...70 °C
Vibration resistance	10 gn (f= 10...150 Hz) conforming to EN/IEC 60068-2-6
Shock resistance	50 gn 11 ms conforming to EN/IEC 60068-2-27
IP degree of protection	IP66 conforming to IEC 60529 IP67 conforming to IEC 60529

Packing Units

Unit Type of Package 1	PCE
Number of Units in Package 1	1
Package 1 Height	7.3 cm
Package 1 Width	24.6 cm
Package 1 Length	5.6 cm
Package 1 Weight	520 g
Unit Type of Package 2	S02
Number of Units in Package 2	10
Package 2 Height	15 cm
Package 2 Width	30 cm
Package 2 Length	40 cm
Package 2 Weight	5.655 kg
Unit Type of Package 3	P06
Number of Units in Package 3	160
Package 3 Height	75 cm
Package 3 Width	40 cm
Package 3 Length	80 cm
Package 3 Weight	101 kg

Offer Sustainability

Sustainable offer status	Green Premium product
REACH Regulation	 REACH Declaration
EU RoHS Directive	Pro-active compliance (Product out of EU RoHS legal scope)  EU RoHS Declaration
Mercury free	Yes
RoHS exemption information	 Yes
Environmental Disclosure	 Product Environmental Profile
California proposition 65	WARNING: This product can expose you to chemicals including: Diisononyl phthalate (DINP), which is known to the State of California to cause cancer, and Di-isodecyl phthalate (DIDP), which is known to the State of California to cause birth defects or other reproductive harm. For more information go to www.P65Warnings.ca.gov

Dimensions

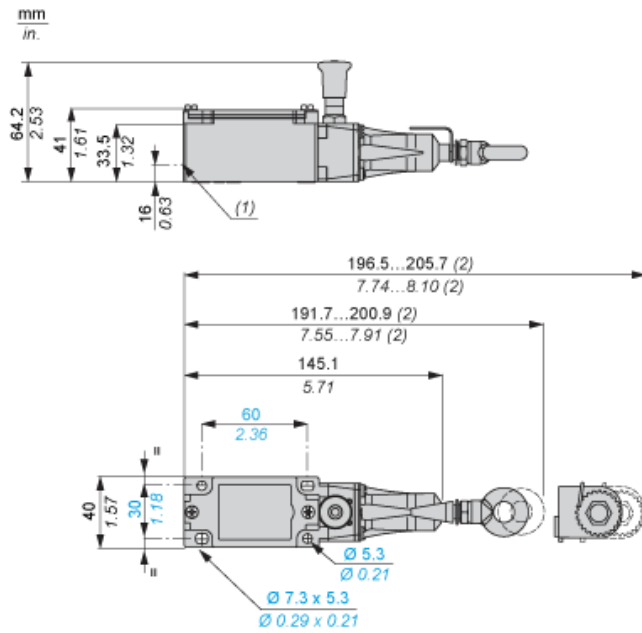

- (1) Tapped entry for n° 13 (Pg 13.5) cable entry
(2) Maximum extension.

Electrical Curves

AC Supply 50/60 Hz Inductive Circuit

2-pole Contact Block

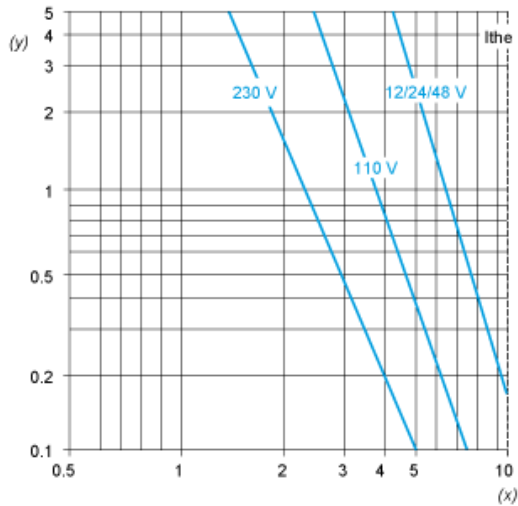

Y Millions of operating cycles
X Current in A

DC Supply Power Broken in for 1 Million Operating Cycles Inductive Circuit

Voltage	V	24	48	120
<i>mm</i>	W	13	9	7