

# XS4P12PA340

Inductive proximity sensors XS, inductive sensor XS4 M12, L35mm, PPS, Sn4mm, 12...24 VDC, cable 2 m



## Main

Range of product	Telemecanique Inductive proximity sensors XS
Series name	General purpose
Sensor type	Inductive proximity sensor
Sensor name	XS4
Sensor design	Cylindrical M12
Size	35 mm
Body type	Fixed
Detector flush mounting acceptance	Non flush mountable
Material	Plastic
Type of output signal	Discrete
Wiring technique	3-wire
[Sn] nominal sensing distance	4 mm
Discrete output function	1 NO
Output circuit type	DC
Discrete output type	PNP
Electrical connection	Cable
Cable length	2 m
[Us] rated supply voltage	12...24 V DC with reverse polarity protection
Switching capacity in mA	<= 200 mA DC with overload and short-circuit protection
IP degree of protection	IP68 double insulation conforming to IEC 60529

## Complementary

Thread type	M12 x 1
Detection face	Frontal
Front material	PPS
Enclosure material	PPS
Operating zone	0...3.2 mm
Differential travel	1...15% of Sr
Cable composition	3 x 0.34 mm <sup>2</sup>
Wire insulation material	PVC
Status LED	Output state: 1 LED (yellow)
Supply voltage limits	10...36 V DC
Switching frequency	<= 5000 Hz
Maximum voltage drop	<2 V (closed)
Current consumption	<= 10 mA no-load
Maximum delay first up	10 ms
Maximum delay response	0.1 ms
Maximum delay recovery	0.1 ms
Marking	CE
Threaded length	25 mm
Height	12 mm
Length	35 mm
Net weight	0.06 kg

## Environment

Product certifications	Ecolab[RETURN]CSA[RETURN]UL
Ambient air temperature for operation	-25...70 °C
Ambient air temperature for storage	-40...85 °C
Vibration resistance	25 gn amplitude = +/- 2 mm (f = 10...55 Hz) conforming to IEC 60068-2-6
Shock resistance	50 gn for 11 ms conforming to IEC 60068-2-27

## Packing Units

Unit Type of Package 1	PCE
Number of Units in Package 1	1
Package 1 Height	4.200 cm
Package 1 Width	9.600 cm
Package 1 Length	13.000 cm
Package 1 Weight	66.000 g
Unit Type of Package 2	S03
Number of Units in Package 2	44
Package 2 Height	30 cm
Package 2 Width	30 cm
Package 2 Length	40 cm
Package 2 Weight	3.356 kg

## Offer Sustainability

Sustainable offer status	Green Premium product
Circularity Profile	<a href="#">End of Life Information</a>
California proposition 65	WARNING: This product can expose you to chemicals including: Diisononyl phthalate (DINP), which is known to the State of California to cause cancer, and Di-isodecyl phthalate (DIDP), which is known to the State of California to cause birth defects or other reproductive harm. For more information go to <a href="http://www.P65Warnings.ca.gov">www.P65Warnings.ca.gov</a>
For all Reach Rohs enquiries contact us at	<a href="mailto:sustainability@tesensors.com">sustainability@tesensors.com</a>

## Contractual warranty

Warranty	18 months
----------	-----------

Dimensions

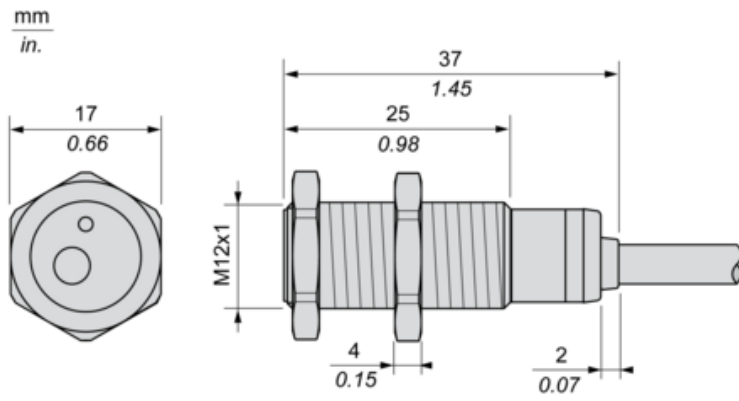

### Minimum Mounting Distances

Side by side

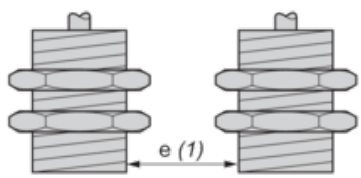

$e (1) \geq 16 \text{ mm}/0.63 \text{ in.}$

Face to face

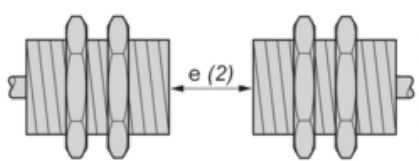

$e (2) \geq 48 \text{ mm}/1.89 \text{ in.}$

Facing a metal object

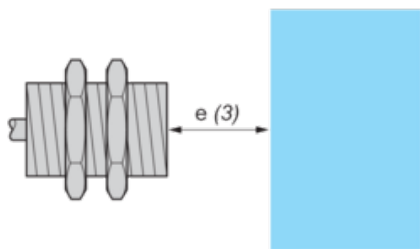

$e (3) \geq 12 \text{ mm}/0.47 \text{ in.}$

Mounted in a metal support

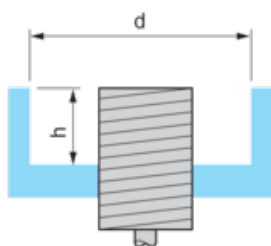

$d \geq 36 \text{ mm}/1.42 \text{ in.}$

$h \geq 8 \text{ mm}/0.31 \text{ in.}$

### Mounting

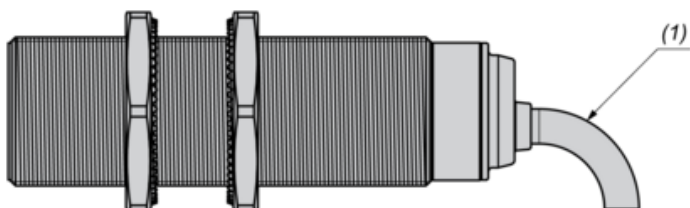

(1) Bending cable: 4 x external cable diameter

---

## Wiring Schemes

---

PNP

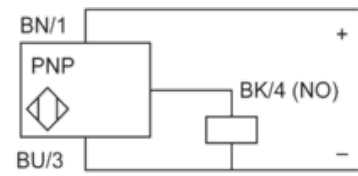

BU : Blue  
BN : Brown  
BK : Black

## Performance Curves

Standard Steel Target : 12x12x1 mm

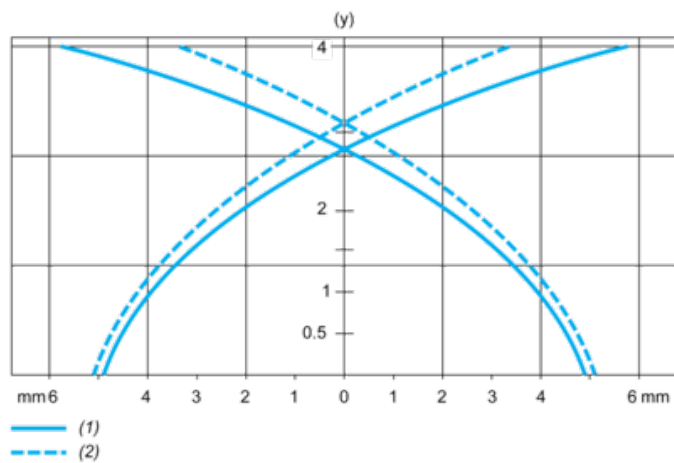

(1) Pick-up points

(2) Drop-out points (object approaching from the side)

(y) Sensing distance in mm